



LOSS PREVENTION

FASTENERS & TOOLS™

div of Ultra Fasteners Inc

www.LPfast.com

PH 1.888.584.6283

Stopping Theft Every Day™



Security Fasteners

Ask About Custom, Non Standard & Made to Order Security



A Buy America Act Supplier



Tamper Resistant ▪ **Tamper Proof** ▪ **High Security**
Anchors ▪ **Nuts** ▪ **Bolts** ▪ **Screws** ▪ **Penta** ▪ **Concrete**

QUESTIONS, QUOTES & SOLUTIONS:

PH 1.888.584.6283 • **sales@LPfast.com** • **www.LPfast.com**





LOSS PREVENTION
FASTENERS & TOOLS®
STOPPING THEFT EVERY DAY.™

for immediate assistance call 1.888.584.6283 ext 500



High security, tamper resistant & anti-theft Inch & Metric, Various Materials

Table of Contents

Many security products not listed, call for tech sheets

Tools, All	Pages 40 - 47	License Plate Screws	Page 40,47	Sign Security	Page 39
316 Stainless Screws	Page 31	Masonry (tapcon style)	Page 6	Slot-Lok Screws + Nuts	Page 23
5 Lobe Pin Screws	Page 29	One Way Screws	Page 32	Spanner Snake Eyes	Page 27
6 Lobe Pin Screws	Page 31	Oval Head Drill Point	Page 14	Strike Plate screws	Page 14
Anchors, Sleeve	Pages 7-10	Penta Bolts & Lags	Pages 12, 13	Switch Plate Screws	Page 22
Anchors, Wedge	Page 8, 9	Phillips Pin	Page 27	T-41 Slope Nuts	Page 39
Avsafe (oval pan)	Page 30	Rivets, Security	Page 38	T-Groove Nuts Steel Zinc	Page 20
Captive Panel Screws	Page 33	Roby Pin (square drive)	Page 28	T-Groove Nuts SS	Pages 21-24
Cladding screws	Page 14	S7 Nuts	Page 23	T-Groove Screws	Page 39
Custom, Non Standard	Page 4	S7 Screws	Page 29	T-Groove Tools, Sockets	Page 40
Electrical Screws	Page 36	Sealing Screws	Page 33	Thread Forming	Page 17
Drill Point (tek)	Page 12, 13	Set Screws	Page 34	Toggle Bolts	Page 26
Flex-Lok Nuts	Page 47	Sex Nuts (male & female)	18, 19	Tork Bolts (break off bolts)	Page 25
Flat Head Undercut	Page 16	Shackles	Page 37	Tork Nuts (break off nuts)	Page 11
Glazing Bead screw	Page 14	SHCS (socket head capscrew)	Page 34	Ultra Lok II	Page 28
Hex Pin	Page 31	SHCS Shoulder Bolts	Page 34	Ultra-Lok P	Page 28
Hinge Screws	Page 14	Shoulder Screws	Page 16	Wire Theft	Page 41

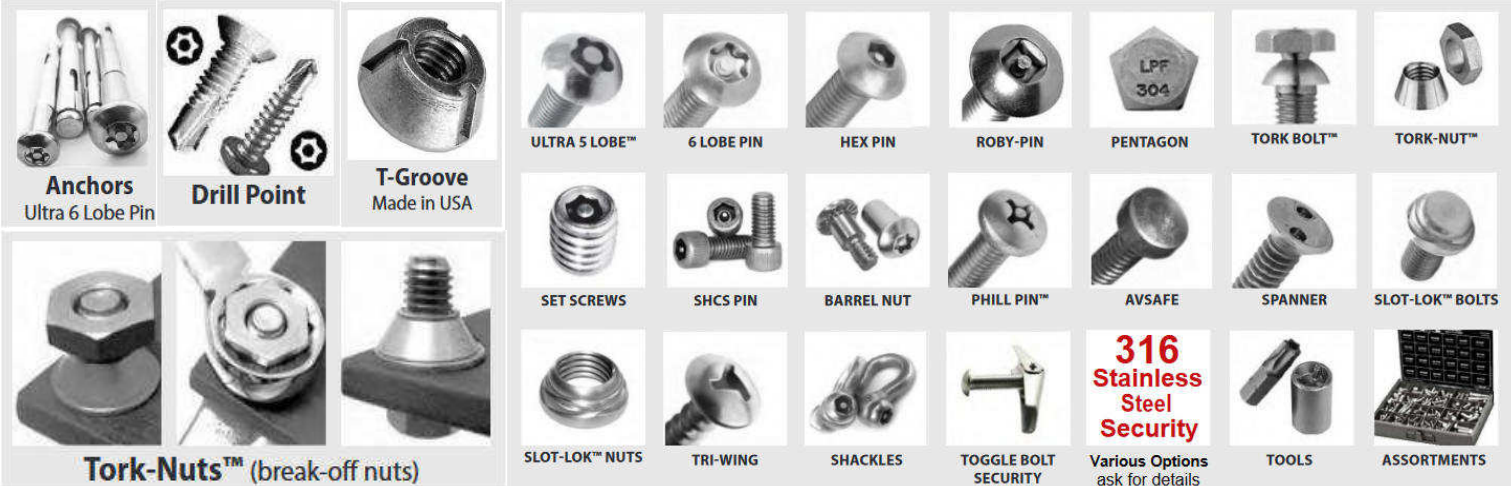

Everything you need: Technical support, custom solutions and timely delivery

QUESTIONS, QUOTES & SOLUTIONS: TOLL-FREE 1.888.584.6283 OR SALES@LPFAST.COM



LOSS PREVENTION FASTENERS & TOOLS[®] STOPPING THEFT EVERY DAY.[™]



High Security, Tamper Resistant, Anti-Theft
Security options vary by size, style, material & quantity.

Sharp Point / Tapping Screws, Type A, AB,

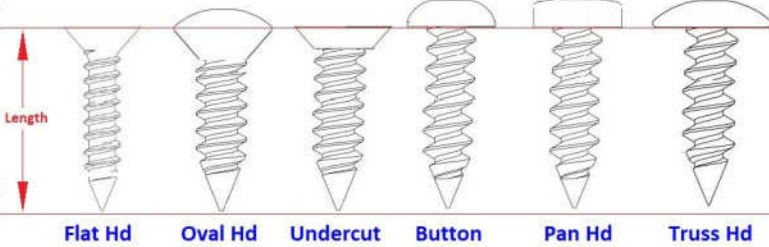

Drill Point / Tek Screws

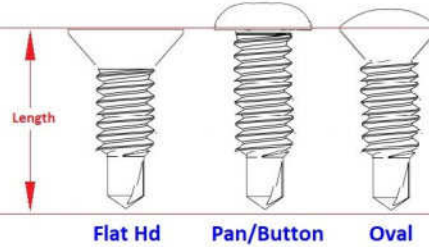

Masonry (Security tapcon style)

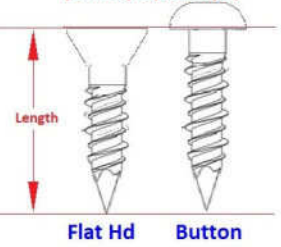

Penta Head 	Penta Lag, Auger, Coil 	Penta Machine Bolt 	Penta Captive 	Tork Bolts (break off bolts)
Flat to Point	Length	Length	Length	Tork Bolts
Flat to Point		Washer O.D.		

Machine Screws

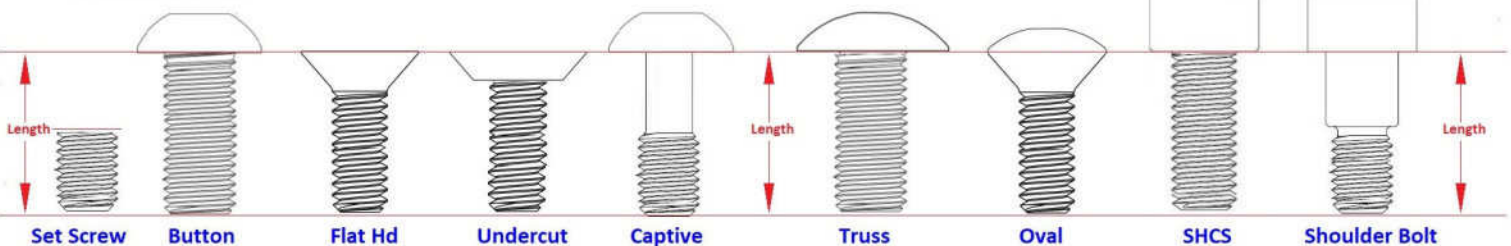

Anchors 	Male / Female 	Slot Lok 	- Extra Long - Large Diameters - Miniature - Custom - 316 Stainless - Thread making
Sleeve Anchors	Sex Nuts		security options vary by size
Wedge	Architectural female		
Spyke			
Drop-In			

Nuts 							
Penta Nut	T-Groove	Slot-Lok	Ultra-Lok S7	Spanner	Ultra-Lok P	Tork Nuts	T-41 Slope Nut

Everything you need: Technical support, custom solutions and timely delivery

QUESTIONS, QUOTES & SOLUTIONS: TOLL-FREE 1.888.584.6283 OR SALES@LPFAST.COM



LOSS PREVENTION
FASTENERS & TOOLS®
STOPPING THEFT EVERY DAY.™



**Everything you need in security fasteners
technical support, custom solutions & timely delivery.**

High Security, Tamper Resistant, Anti-Theft

Nuts, Bolts, Screws, Anchors, Penta & Custom Solutions

All sizes: inch & metric

True blind drop shipments

Various materials

Cut sheets / technical data

Custom & non-standard

Package, mini-bulk and 1/4 keg



A Buy America Act supplier

Custom, Non Standard & Special Fasteners

made to order, inch & metric, various materials

Security

minature to oversize

Non Security



sales@LPfast.com



Source

LPfast.com is your source for hard to find & custom fasteners.



Solutions

Our team of fastener specialists are available by phone & email.



Supply

Our USA factory has capabilities beyond security fasteners.

QUESTIONS, QUOTES & SOLUTIONS: toll-free 1.888.584.6283 or sales@LPfast.com



LOSS PREVENTION

FASTENERS & TOOLS®
STOPPING THEFT EVERY DAY.™

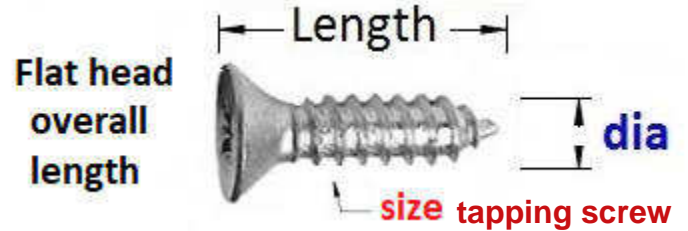
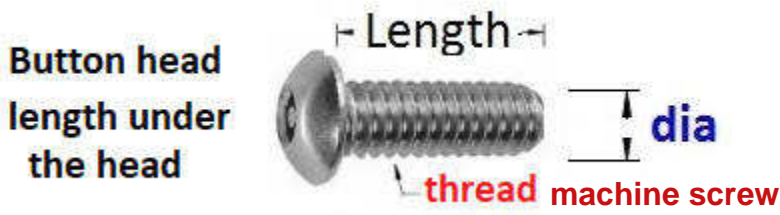

Tapping Screw common sizes	INCH machine screws common sizes	FRACTION	DECIMAL	MM	METRIC machine screws common sizes
		$\frac{1}{64}$.0156	0.396	
		$\frac{1}{32}$.0312	0.793	
		$\frac{3}{64}$.0468	1.190	
	.060" 0-80	$\frac{1}{16}$.0625	1.587	1.4mm x 0.3
#2 screw	.073" 1-72	$\frac{3}{64}$.0781	1.984	1.6mm x 0.35
#3 screw	.086" 2-56	$\frac{3}{32}$.0937	2.381	2mm x 0.4
#4 screw	.099" 3-48	$\frac{7}{64}$.1093	2.778	2.5mm x 0.45
	.112" 4-40	$\frac{1}{8}$.125	3.175	3mm x 0.5
#6 screw	.138" 6-32	$\frac{9}{64}$.1406	3.571	3.5mm x 0.6
#8 screw	.164" 8-32	$\frac{5}{32}$.1562	3.968	
#10 screw	.190" & 10-24	$\frac{11}{64}$.1718	4.365	4mm x 0.7
	10-32	$\frac{3}{16}$.1875	4.762	
#12 screw	.216" 12-24	$\frac{7}{32}$.2031	5.156	5mm x 0.8
		$\frac{15}{64}$.2187	5.556	
#14 screw .242"	.250" 1/4-20	$\frac{1}{4}$.2343	5.953	6mm x 1.0
		$\frac{17}{64}$.250	6.350	
#18 screw .294"		$\frac{9}{32}$.2656	6.746	
		$\frac{19}{64}$.2812	7.143	
#20 screw .320"	.3125" 5/16-18	$\frac{5}{16}$.2968	7.540	
		$\frac{21}{64}$.3125	7.937	
		$\frac{11}{32}$.3281	8.334	8mm x 1.25
#24 screw .372"		$\frac{23}{64}$.3437	8.731	
	.375" 3/8-16	$\frac{3}{8}$.3593	9.128	
		$\frac{25}{64}$.375	9.525	
		$\frac{13}{32}$.3906	9.921	
		$\frac{27}{64}$.4062	10.318	10mm x 1.50
	.437" 7/16-14	$\frac{7}{16}$.4218	10.715	
		$\frac{29}{64}$.4375	11.112	
		$\frac{15}{32}$.4531	11.509	
		$\frac{31}{64}$.4687	11.906	
		$\frac{1}{2}$.4843	12.303	12mm x 1.75
	.500" 1/2-13		.500	12.700	

SECURITY CONCRETE SCREWS ULTRA 6 LOBE MASONRY (1/4" dia.)



FAST & EASY TO INSTALL IN CONCRETE, BRICK, MASONRY AND HOLLOW BLOCK

- Security tamper-proof masonry screw
- Special high-low thread design cuts into masonry materials, providing a stable, fast and accurate installation.
- Climate-Coat® protection for corrosion resistance: Formulated for long life protection, providing optimal corrosion resistance properties (ASTM B117)
- Button & Flat head

made in USA



made in USA

1/4" dia.



Made in the USA

Steel with Climate-Coat® protection

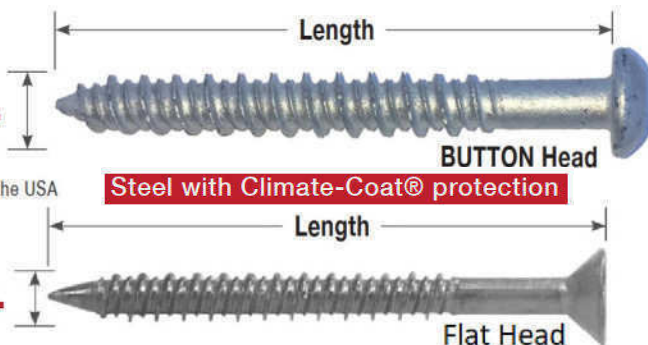

Security pin



Excellent 6-point tool engagement

Installation Tool Part # 27T.250B

SIZE (DIA. x LENGTH) * inch	BUTTON Head Part Number	FLAT Head Part Number	HOLE DIAMETER IN BASE MATERIAL
1/4 x 1-1/4	14.1250TBC	14.1250TFC	3/16"
1/4 x 1-3/4	14.1750TBC	14.1750TFC	3/16"
1/4 x 2-1/4	14.2250TBC	14.2250TFC	3/16"
1/4 x 2-3/4	14.2750TBC	14.2750TFC	3/16"

* To determine the minimum length of screw required, add the thickness of the material to be fastened to the minimum embedment for the diameter of screw being installed (see diagram and chart below).



Straight Shank concrete bit PART # 70697
3/16 dia, 4" drill depth, 6" Length,



SDS PLUS concrete bit PART # 70699
3/16 dia, 4" drill depth, 6-1/4" Length,

ULTRA 6 Lobe with Security Pin MASONRY BOLT

**High Strength Carbon Steel
Climate-Coat Protected
Hole Size is Bolt Size**

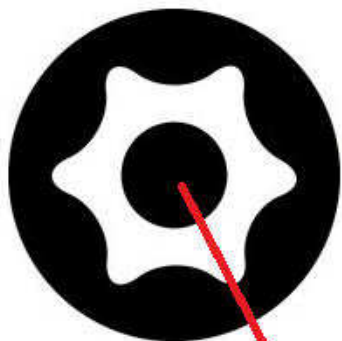

Security Pin

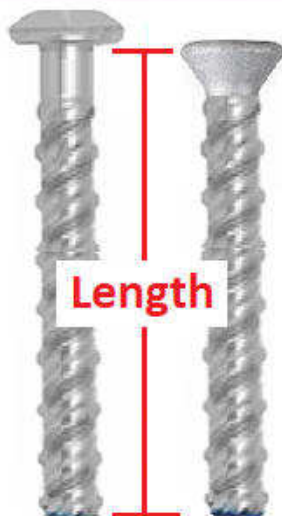

PART # 375.300TFM Install Tool PART # 45T.3125B
Desc: 3/8 x 3 Flat head, Ultra 6 Lobe Pin, Climate-Coat

PART # 375.400TFM Install Tool PART # 45T.3125B
Desc: 3/8 x 4 Flat head, Ultra 6 Lobe Pin, Climate-Coat

PART # 375.300TBM Install Tool PART # 45T.3125B
Desc: 3/8 x 3 Button head, Ultra 6 Lobe Pin, Climate-Coat

PART # 375.400TBM Install Tool PART # 45T.3125B
Desc: 3/8 x 4 Button head, Ultra 6 Lobe Pin, Climate-Coat

PART # 500.300TBM Install Tool Part # 50T.250B
Desc: 1/2 x 3 Button head, Ultra 6 Lobe Pin, Climate-Coat

SECURITY SLEEVE ANCHOR

Stopping Theft Every Day™



FAST & EASY TO INSTALL IN CONCRETE, BRICK AND STONE-BASED MATERIALS



1/4" dia Button Head		
SIZE 1/4" dia (DIA. x LENGTH)	PART NUMBER, Zinc Body Stainless Steel Head,	PART NUMBER All Stainless
1/4 x 1-1/4	250.1250TBSZ	
1/4 x 2	250.200TBSZ	250.200TBSS
1/4 x 2-3/4	250.2750TBSZ	250.2750TBSS
1/4 x 3-3/4	250.3750TBSZ	250.3750TBSS
1/4 x 5	250.500TBSZ	
Installation Driver Bit Part Number		27T.250B

1/4" dia Flat Head		
SIZE dia (DIA. x LENGTH)	PART NUMBER, Zinc Body Stainless Steel Head,	PART NUMBER All Stainless
1/4 x 1-1/2	250.1500TFSZ	
1/4 x 2	250.200TFSZ	250.200TFSS
1/4 x 3	250.300TFSZ	250.300TFSS
1/4 x 4	250.400TFSZ	250.400TFSS
Installation Driver Bit Part Number		30T.250B

3/8" dia Button Head		
SIZE 3/8" dia (DIA. x LENGTH)	PART NUMBER, Zinc Body Stainless Steel Head,	PART NUMBER All Stainless
3/8 x 2-1/2	375.2500TBSZ	375.2500TBSS
3/8 x 3-3/4	375.3750TBSZ	375.3750TBSS
3/8 x 4-3/4	375.4750TBSZ	375.4750TBSS
3/8 x 6"	375.600TBSZ	
Installation Driver Bit Part Number		45T.3125B

3/8" dia Flat Head		
SIZE dia (DIA. x LENGTH)	PART NUMBER, Zinc Body Stainless Steel Head,	PART NUMBER All Stainless
3/8 x 2-3/4	375.2750TFSZ	375.2750TFSS
3/8 x 4	375.400TFSZ	375.400TFSS
3/8 x 5	375.500TFSZ	375.500TFSS
3/8 x 6	375.600TFSZ	375.600TFSS
Installation Driver Bit Part Number		45T.3125B

1/2" dia Button Head		
SIZE 1/2" dia (DIA. x LENGTH)	PART NUMBER, Zinc Body Stainless Steel Head,	PART NUMBER All Stainless
1/2 x 3-1/4	500.3250TBSZ	500.3250TBSS
1/2 x 4	500.400TBSZ	500.400TBSS
1/2 x 5	500.500TBSZ	500.500TBSS
1/2 x 7	500.700TBSZ	500.700TBSS
Installation Driver Bit Part Number		55T.3125B

1/2" dia Flat Head		
SIZE dia (DIA. x LENGTH)	PART NUMBER, Zinc Body Stainless Steel Head,	PART NUMBER All Stainless
1/2 x 3-1/2	500.3500TFSZ	500.3500TFSS
1/2 x 4	500.400TFSZ	500.400TFSS
1/2 x 5-1/4	500.5250TFSZ	500.5250TFSS
1/2 x 7	500.700TFSZ	500.700TFSS
Installation Driver Bit Part Number		50T.3125B

5/8" & 3/4" diameter please call for available sizes

* Anchor lengths are measured from underneath the head.

* To determine the minimum length of anchor required, add the thickness of the material to be fastened to the minimum embedment for the diameter of anchor being installed.

Installation

1. Drill a hole into the base material at least 3/8" deeper than the anchor length. Make the hole the same size as the anchor diameter (3/8" hole for 3/8" anchor).
 2. Blow the hole clean using compressed air. Alternatively, drill the hole deep enough to accommodate embedment length and drilling dust.
 3. Install the Ultra 6 Lobe security anchor through the fixture directly into the base material.
 4. Tighten to required installation torque (see below).
- IMPORTANT:** Make sure the hole in the item being attached is slightly larger than the anchor diameter.

5/8" dia & 3/4" dia available, min qty may apply call for details 1.888.584.6283

Technical Data Sheets
 Technical data sheets available upon request, no charge. Please call or email .



LOSS PREVENTION
FASTENERS & TOOLS®
STOPPING THEFT EVERY DAY.™



Security Wedge Anchors

Call our Fastener Specialists for immediate support & tech data sheets

Ask about Made in USA for this product group



3/8 dia x Overall Length hole size 3/8"	Steel Zinc Plated Security nut with Steel Zinc Plated wedge anchor	Stainless Steel Security nut with 304 Stainless Steel wedge anchor	316 Stainless Steel Security nut with 316 Stainless Steel wedge anchor	Thread Length (in.)
3/8 x 2-1/4	375.2250TGW	375.2250TGWSS	375.2250TGW316	1-1/8
3/8 x 2-3/4	375.2750TGW	375.2750TGWSS	375.2750TGW316	1-5/8
3/8 x 3	375.300TGW	375.300TGWSS	375.300TGW316	1-7/8
3/8 x 3-1/2	375.35000TGW	375.3500TGWSS	375.3500TGW316	2-1/2
3/8 x 3-3/4	375.3750TGW	375.3750TGWSS	375.3750TGW316	2-5/8
3/8 x 5	375.500TGW	375.500TGWSS	375.500TGW316	3-7/8
3/8 x 7	375.700TGW	375.700TGWSS	375.700TGW316	5-7/8

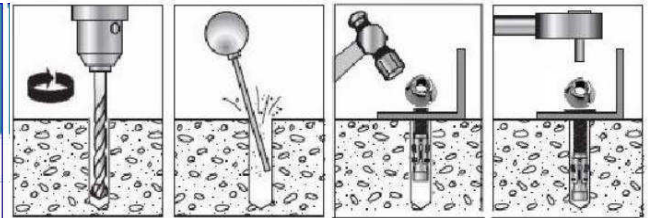

Installation

- ⚠ Do not use an impact wrench to set or tighten the anchor.**
- ⚠ 1. Drill a hole in the base material using a carbide drill bit the same diameter as the nominal diameter of the anchor to be installed. Drill the hole to the specified minimum hole depth, and blow it clean using compressed air. (Overhead installations need not be blown clean.) Alternatively, drill the hole deep enough to accommodate embedment depth and dust from drilling.**
- ⚠ 2. Assemble the anchor with nut and washer so the top of the nut is flush with the top of the anchor. Place the anchor in the fixture, and drive it into the hole until the washer and nut are tight against the fixture. Tighten without the use of impact tool.**

3/8" T-Groove Nut
 Width at base .830"
 Overall Height .340"

Install Sockets
3/8 Part # LPF430
 3/8 drive standard socket
3/8 Part # LPF430.2
 3/8 drive DEEP socket

1/2" T-Groove Nut
 Width at base .945"
 Overall Height .345"

Install Sockets
1/2 Part # LPF440
 1/2 drive standard socket
1/2 Part # LPF440.2
 1/2 drive DEEP socket

1/2 dia x Overall Length hole size 1/2"	Steel Zinc Plated Security nut with Steel Zinc Plated wedge anchor	Stainless Steel Security nut with 304 Stainless Steel wedge anchor	316 Stainless Steel Security nut with 316 Stainless Steel wedge anchor	Thread Length (in.)
1/2 x 2 3/4	500.2750TGW	500.2750TGWSS	500.2750TGW316	1-1/8
1/2 x 3 3/4	500.3750TGW	500.3750TGWSS	500.3750TGW316	1-5/8
1/2 x 4 1/4	500.4250TGW	500.4250TGWSS	500.4250TGW316	1-7/8
1/2 x 5 1/2	500.5500TGW	500.5500TGWSS	500.5500TGW316	2-1/2
1/2 x 7	500.700TGW	500.700TGWSS	500.700TGW316	2-5/8
1/2 x 8 1/2	500.8500TGW	500.8500TGWSS	500.8500TGW316	3-7/8
1/2 x 10	500.1000TGW	500.1000TGWSS	500.1000TGW316	5-7/8
1/2 x 12	500.1200TGW	500.1200TGWSS	500.1200TGW316	5-7/8

Everything you need: Technical support, custom solutions and timely delivery

QUESTIONS, QUOTES & SOLUTIONS: TOLL-FREE 1.888.584.6283 OR SALES@LPFAST.COM



LOSS PREVENTION
FASTENERS & TOOLS®
STOPPING THEFT EVERY DAY.™



Security Wedge Anchors

Call our Fastener Specialists for immediate support & tech data sheets

Ask about Made in USA for this product group

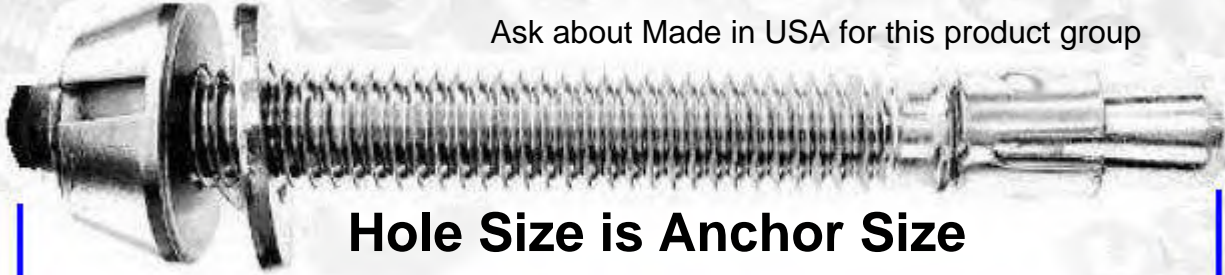

Dia

5/8 & 3/4

Hole Size is Anchor Size

Length

5/8 dia x Overall Length hole size 5/8"	Steel Zinc Plated Security nut with Steel Zinc Plated wedge anchor	Stainless Steel Security nut with 304 Stainless Steel wedge anchor	316 Stainless Steel Security nut with 316 Stainless Steel wedge anchor	Thread Length (in.)
5/8 x 3-1/2	625.3500TGW	625.3500TGWSS	625.3500TGW316	2-3/8"
5/8 x 4-1/2	625.4500TGW	625.4500TGWSS	625.4500TGW316	2-7/8"
5/8 x 5	625.500TGW	625.500TGWSS	625.500TGW316	3-5/8"
5/8 x 6	625.600TGW	625.600TGWSS	625.600TGW316	4-3/8"
5/8 x 7	625.700TGW	625.700TGWSS	625.700TGW316	5-1/8"
5/8 x 8-1/2	625.8500TGW	625.8500TGWSS	625.8500TGW316	6"
5/8 x 10	625.10000TGW	625.1000TGWSS	625.1000TGW316	6"
5/8 x 12	625.12000TGW	625.12000TGWSS	625.12000TGW316	6"

MOQ may apply on this column

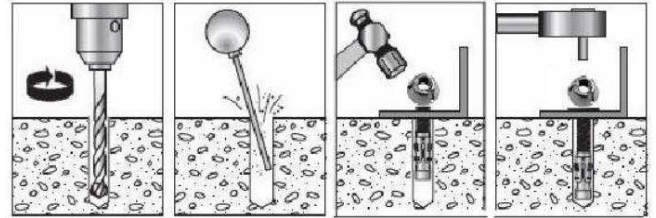

Installation

- ⚠ Do not use an impact wrench to set or tighten the anchor.**
- ⚠ 1. Drill a hole in the base material using a carbide drill bit the same diameter as the nominal diameter of the anchor to be installed. Drill the hole to the specified minimum hole depth, and blow it clean using compressed air. (Overhead installations need not be blown clean.) Alternatively, drill the hole deep enough to accommodate embedment depth and dust from drilling.**
- ⚠ 2. Assemble the anchor with nut and washer so the top of the nut is flush with the top of the anchor. Place the anchor in the fixture, and drive it into the hole until the washer and nut are tight against the fixture. Tighten without the use of impact tool.**



5/8 & 3/4 T-Groove Nut
 width at base 1.500"
 overall height 0.475"



Install Socket

5/8 Part # LPF475
3/4 Part # LPF475

3/4 dia x Overall Length hole size 3/4"	Steel Zinc Plated Security nut with Steel Zinc Plated wedge anchor	Stainless Steel Security nut with 304 Stainless Steel wedge anchor	316 Stainless Steel Security nut with 316 Stainless Steel wedge anchor	Thread Length (in.)
3/4 x 4-1/4	750.4250TGW	750.4250TGWSS	750.4250TGW316	2-3/8"
3/4 x 4-3/4	750.4750TGW	750.4750TGWSS	750.4750TGW316	2-7/8"
3/4 x 5-1/2	750.5500TGW	750.5500TGWSS	750.5500TGW316	3-5/8"
3/4 x 6-1/4	750.6250TGW	750.6250TGWSS	750.6250TGW316	4-3/8"
3/4 x 7	750.700TGW	750.700TGWSS	750.700TGW316	5-1/8"
3/4 x 8-1/2	750.8500TGW	750.8500TGWSS	750.8500TGW316	6"
3/4 x 10	750.1000TGW	750.1000TGWSS	750.1000TGW316	6"
3/4 x 12	750.12000TGW	750.12000TGWSS	750.12000TGW316	6"

MOQ may apply on this column

Everything you need: Technical support, custom solutions and timely delivery

QUESTIONS, QUOTES & SOLUTIONS: TOLL-FREE 1.888.584.6283 OR SALES@LPFAST.COM

T-Groove SLEEVE ANCHORS

 **Made in USA**



FAST & EASY TO INSTALL IN CONCRETE, BRICK AND STONE-BASED MATERIALS

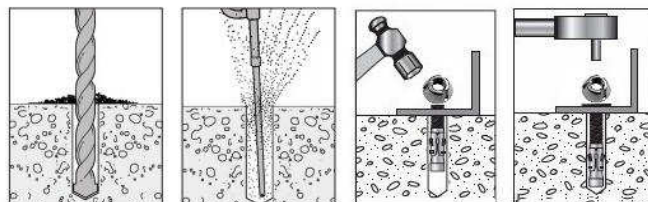
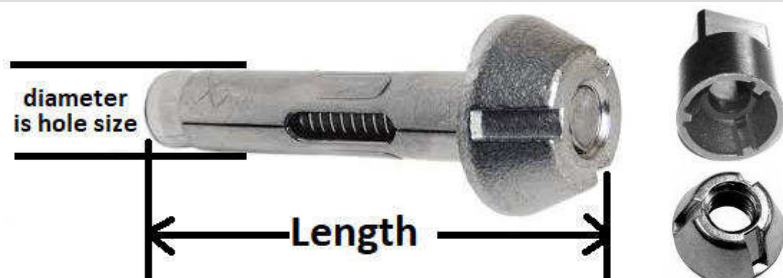

Installation

 Do not use an impact wrench to set or tighten the anchor.

1/4" Dia SIZE	Steel/Zinc Part Number	All Stainless Part Number	Hole Size	T-Groove Nut Dimensions	Install Sockets Part #'s Standard Deep
1/4 X 5/8	250.625TGS AZ	250.625TGS ASS	1/4"	width .661"	LPF420 LPF420.2
1/4 X 1-3/8	250.1375TGS AZ	250.1375TGS ASS		height 2600"	
1/4 X 2-1/4	250.2250TGS AZ	250.2250TGS ASS			
1/4 X 3	250.300TGS AZ	250.300TGS ASS			

5/16" Dia SIZE	Steel/Zinc Part Number	All Stainless Part Number	Hole Size	T-Groove Nut Dimensions	Install Sockets Part #'s Standard Deep
5/16 X 1-1/2	312.1500TGS AZ	312.1500TGS ASS	5/16"	width .830"	LPF430 LPF430.2
5/16 X 2	312.200TGS AZ	312.200TGS ASS		height .380"	

3/8" Dia SIZE	Steel/Zinc Part Number	All Stainless Part Number	Hole Size	T-Groove Nut Dimensions	Install Sockets Part #'s Standard Deep
3/8 X 1-1-7/8	375.1875TGS AZ	375.1875TGS ASS	3/8"	width .830"	LPF430 LPF430.2
3/8 X 3	375.300TGS AZ	375.300TGS ASS		height .380"	
3/8 X 4	375.400TGS AZ	375.400TGS ASS			
3/8 X 6	375.600TGS AZ	375.600TGS ASS			

1/2" Dia SIZE	Steel/Zinc Part Number	All Stainless Part Number	Hole Size	T-Groove Nut Dimensions	Install Sockets Part #'s Standard Deep
1/2 X 2-1/4	500.2250TGS AZ	500.2250TGS ASS	1/2"	width .945"	LPF440 LPF440.2
1/2 X 3	500.300TGS AZ	500.300TGS ASS		height .345"	
1/2 X 4	500.400TGS AZ	500.400TGS ASS			
1/2 X 6	500.600TGS AZ	500.600TGS ASS			

5/8" Dia SIZE	Steel/Zinc Part Number	All Stainless Part Number	Hole Size	T-Groove Nut Dimensions	Install Socket Universal Deep Socket #
5/8 X 3	625.300TGS AZ	625.300TGS ASS	5/8"	width 1.500"	LPF475
5/8 X 4	625.400TGS AZ	625.400TGS ASS		height 0.475"	
5/8 X 6	625.600TGS AZ	625.600TGS ASS			

3/4" Dia SIZE	Steel/Zinc Part Number	All Stainless Part Number	Hole Size	T-Groove Nut Dimensions	Install Socket Universal Deep Socket #
3/4 X 3	750.300TGS AZ	750.300TGS ASS	3/4"	width 1.500"	LPF475
3/4 X 4	750.400TGS AZ	750.400TGS ASS		height 0.475"	
3/4 X 6	750.600TGS AZ	750.600TGS ASS			

STOPPING THEFT EVERY DAY.™

Continued next page

TORK-NUTS



LOSS PREVENTION FASTENERS
div of Ultra Fasteners Inc

HIGH SECURITY PERMANENT

METRIC sizes in stock



INCH sizes in stock



LPFast Torq-Nuts (Break-Off Nuts) are a cost effective solution for installations that will be permanent, such as fences, signs, prisons OEM's, power transmissions and many more applications..

No Special Tools required. Permanent Security

INCH	Part #	Material	INCH	Part #	Material	METRIC	Part #	Material
10-24.	1024.TNSS	Stainless	10-24.	1024.TNSS	Aluminum	m5 x 0.8	M5.TNSS	Stainless
10-32.	1032.TNSS	Stainless	10-32.	1032.TNA	Aluminum	m6 x 1.0	M6.TNSS	Stainless
1/4-20.	1420.TNSS	Stainless	1/4-20.	1420.TNSS	Aluminum	m8 x 1.25	M8.TNSS	Stainless
5/16-18.	518.TNSS	Stainless	5/16-18.	518.TNSS	Aluminum	m10 x 1.5	M10.TNSS	Stainless
3/8-16.	316.TNSS	Stainless	3/8-16.	316.TNSS	Aluminum	m12 x 1.75	M12.TNSS	Stainless
7/16-14.	714.TNSS	Stainless	7/16-14.					
1/2-13.	113.TNSS	Stainless	1/2-13.	113.TNA		m5 x 0.8	M5.TNSS	Aluminum
5/8-11.	511.TNSS	Stainless	5/8-11.					
3/4-10.	310.TNSS	Stainless	3/4-10.	310.TNA	Aluminum			
--Additional sizes available MOQ may apply----			--Additional sizes available MOQ may apply----			--Additional sizes available MOQ may apply----		
common sizes typically in stock			**common sizes typically in stock**			**common sizes typically in stock**		

Ask about special materials & custom TORQUE break-off (minimum quantities may apply)

10/2018

STOPPING THEFT EVERY DAY.™

Questions, quotes & solutions: toll-free 1.888.584.6283 or sales@LPfast.com | www.LPfast.com

Penta Head

Machine Bolts, Lag Bolts & Tools



Know Your Penta Head Bolts

Head size is measured 'from flat to point'.
Head size is not related to bolt size.

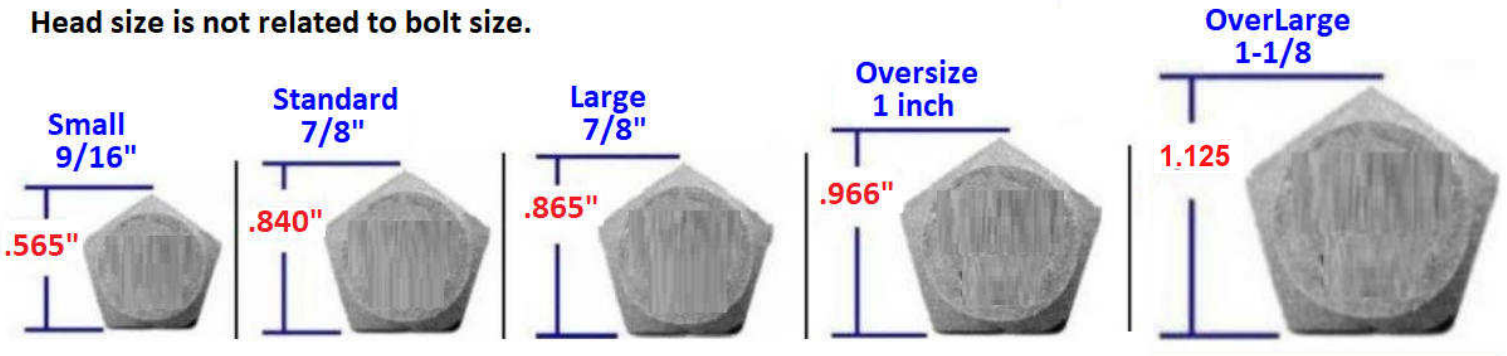

Penta Sockets



PART #562PB.375S
Fits 9/16" Penta Hd

PART #875PB.500S
Fits .840" Penta hd

PART #875PBL.500
Fits .865" Penta hd

PART #100PB.500
Fits .966" Penta hd

PART #125PB.500
Fits 1.125" Penta hd

Penta Head Machine Bolts & Penta Head Lag Screws: Part Numbers on the next page



Penta Head
Machine Bolts

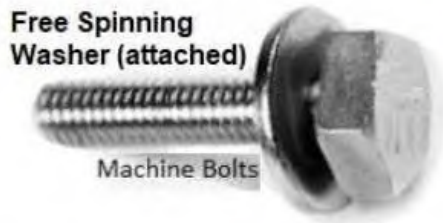

Free Spinning Washer (attached)
Machine Bolts



Measure Head flat to point



Standard Penta Head
Captive Style



Washer Head Full Thread
Machine Bolts



Washer Head Captive Style
Machine Bolts

Custom Sizes & Lengths
min quantity 100 pcs



Penta Head Lag Screw
Coil Thread Compatible

Penta Bolts & Lags
'on the shelf'

Ask about Brass & Silicon Bronze Penta Head Options



LOSS PREVENTION

FASTENERS & TOOLS®

STOPPING THEFT EVERY DAY.™



Small Head Available Upon Request
Minimum quantity may apply

Metric Sizes Available



Ask About Penta Nuts, Penta Clips, & Springs

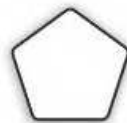

Custom Sizes Available

PENTA HEAD - MACHINE THREAD

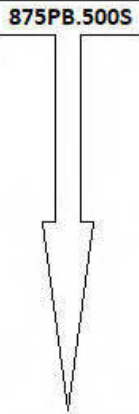
PART#	SIZE	INSTALL SOCKET
1420.XXXXPBSS	1/4-20 x Various Lengths	
518.XXXXPBSS	5/16-18 x Various Lengths	
316.750PBSS	3/8-16 x 3/4	
316.100PBSS	3/8-16 x 1"	
316.1250PBSS	3/8-16 x 1-1/4"	
316.1500PBSS	3/8-16 x 1-1/2"	
316.1750PBSS	3/8-16 x 1-3/4"	
316.200PBSS	3/8-16 x 2"	
316.2250PBSS	3/8-16 x 2-1/4"	
316.2500PBSS	3/8-16 x 2-1/2"	
316.2750PBSS	3/8-16 x 2-3/4"	
316.300PBSS	3/8-16 x 3"	
316.3250PBSS	3/8-16 x 3-1/4"	
316.3500PBSS	3/8-16 x 3-1/2"	
316.3750PBSS	3/8-16 x 3-3/4"	
316.400PBSS	3/8-16 x 4"	
316.XXXXPBSS	3/8-16 x Various Lengths	

PENTA HEAD - MACHINE THREAD

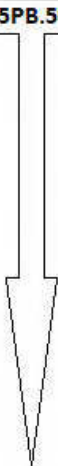
PART#	SIZE	INSTALL SOCKET
113.750PBSS	1/2-13 x 3/4"	
113.100PBSS	1/2-13 x 1"	
113.1250PBSS	1/2-13 x 1-1/4"	
113.1500PBSS	1/2-13 x 1-1/2"	
113.1750PBSS	1/2-13 x 1-3/4"	
113.200PBSS	1/2-13 x 2"	
113.2250PBSS	1/2-13 x 2-1/4"	
113.2500PBSS	1/2-13 x 2-1/2"	
113.2750PBSS	1/2-13 x 2-3/4"	
113.300PBSS	1/2-13 x 3"	
113.3250PBSS	1/2-13 x 3-1/4"	
113.3500PBSS	1/2-13 x 3-1/2"	
113.3750PBSS	1/2-13 x 3-3/4"	
113.400PBSS	1/2-13 x 4"	
113.4500PBSS	1/2-13 x 4-1/2"	
113.XXXXPBSS	1/2-13 x Various Lengths	
511.XXXXPBSS	5/8-11 x Various Lengths	
310.XXXXPBSS	3/4-10 x Various Lengths	

Ask about Brass & Silicon Bronze Penta Head Options

Custom Sizes Available



Captive Panel

Stainless Steel

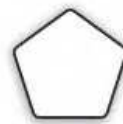



Lag / Coil / Auger Compatible

Custom Sizes Available

PENTA HEAD - LAG SCREW

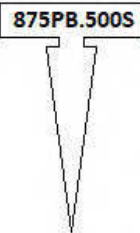
PENTA WASHER HEAD - MACHINE THREAD

PART#	SIZE	INSTALL SOCKET
316.XXXXPBWSSCP	3/8-16 x Various Lengths	
113.3125PBWSSCP	1/2-13 x 1.310	
113.1500PBWSSCP	1/2-13 x 1-1/2"	
113.XXXXPBWSSCP	1/2-13 x Various Lengths	
113.1500PBWBRCP	1/2-13 x 1-1/2 BRASS	
113.2750PBWBRCP	1/2-13 x 2-3/4 BRASS	

PART#	SIZE	INSTALL SOCKET
375.200PBSS	3/8-7 x 2	
375.2500PBSS	3/8-7 x 2-1/2	
375.300PBSS	3/8-7 x 3	
375.3500PBSS	3/8-7 x 3-1/2	
375.400PBSS	3/8-7 x 4	
375.500PBSS	3/8-7 x 5	
375.600PBSS	3/8-7 x 6	
375.700PBSS	3/8-7 x 7	
375.XXXXPBSS	3/8-7 x Various Lengths	
500.2500PBSS	1/2-6 x 2-1/2	
500.300PBSS	1/2-6 x 3	
500.3500PBSS	1/2-6 x 3-1/2	
500.400PBSS	1/2-6 x 4	
500.XXXXPBSS	1/2-6 x Various Lengths	
625.XXXXPBSS	5/8-5 x Various Lengths	
750.XXXXPBSS	3/4-4 x Various Lengths	

Questions, Quotes & Solutions
Call Toll Free 1.888.584.6283
or email: sales@LPfast.com

Ask about Penta Nuts, Clips & Springs



LOSS PREVENTION
FASTENERS & TOOLS®
STOPPING THEFT EVERY DAY.™



Glazing Security screw

Oval Head Drill Point



Steel, Zinc Plated

PART # 6.1250TOTZ
#6 x 1-1/4 Oval Head,
Tool Part # 15T.250B

PART # 8.1250TOTZ
#8 x 1-1/4 Oval Head,
Tool Part # 20T.250B



Security Cladding Screw

Comes with one piece rubber washer bonded to stainless washer to create a tight grip on the joints, and metal backing for strength. Neoprene has good oil and abrasion resistance. Temperature range is -45° to 250° F.

Stainless Steel



Ask About Custom, Non Standard & Made to Order Options

PART # 1224.687TFUTSS

Desc: 12-24 x 11/16 Flat Head UnderCut Stainless

made of
410 Hardened Stainless



Security Pin

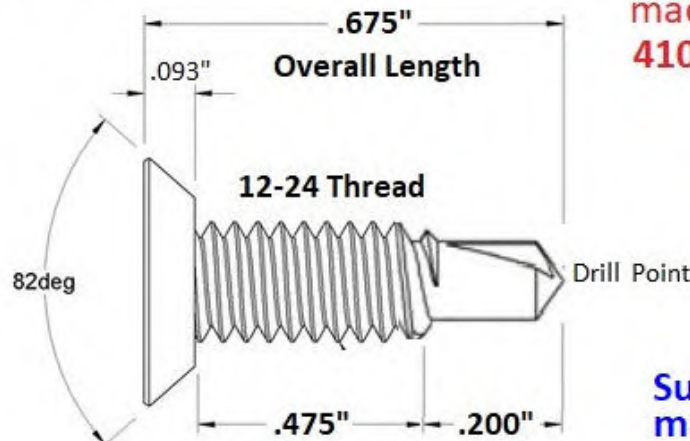

Suitable for use as
machine screws in
pre-threaded holes

Everything you need: Technical support, custom solutions and timely delivery

QUESTIONS, QUOTES & SOLUTIONS: TOLL-FREE 1.888.584.6283 OR SALES@LPFAST.COM



LOSS PREVENTION
FASTENERS & TOOLS®
STOPPING THEFT EVERY DAY.™



Drill Point Security Screws (TEK)

410 Hardened Stainless Steel, 6 Lobe Pin Security

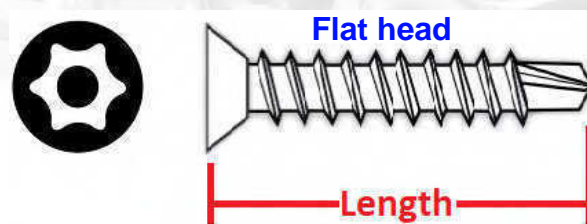
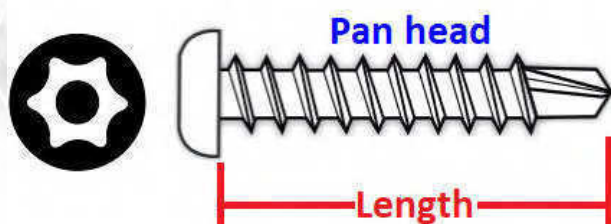

PAN HEAD TEK
410 STAINLESS STEEL

SIZE (in.)	PART NUMBER	TOOL NUMBER
6 x 3/8	6.375TPTSS *	15T.250B
6 x 1/2	6.500TPTSS *	15T.250B
8 x 1/2	8.500TPTSS	20T.250B
8 x 3/4	8.750TPTSS	20T.250B
8 x 1	8.100TPTSS	20T.250B
8 x 1-1/4	8.1250TPTSS	20T.250B
8 x 1-1/2	8.1500TPTSS	20T.250B
10 x 1/2	10.500TPTSS	25T.250B
10 x 3/4	10.750TPTSS	25T.250B
10 x 1	10.100TPTSS	25T.250B
10 x 1-1/4	10.1250TPTSS	25T.250B
10 x 1-1/2	10.1500TPTSS	25T.250B
10 x 2	10.200TPTSS	25T.250B
12 x 1	12.100TPTSS	27T.250B
12 x 1-1/4	12.1250TPTSS	27T.250B
12 x 1-1/2	12.1500TPTSS	27T.250B
12 x 2	12.200TPTSS	27T.250B
14 x 3/4	14.750TPTSS	30T.250B
14 x 1	14.100TPTSS	30T.250B
14 x 1-1/4	14.1250TPTSS *	30T.250B
14 x 1-1/2	14.1500TPTSS	30T.250B
14 x 2	14.200TPTSS	30T.250B
14 x 3	14.300TPTSS	30T.250B

FLAT HEAD TEK
410 STAINLESS STEEL

SIZE (in.)	PART NUMBER	TOOL NUMBER
8 x 1/2	8.500TFTSS	15T.250B
8 x 3/4	8.750TFTSS	15T.250B
8 x 1	8.100TFTSS	15T.250B
8 x 1-1/4	8.12500TFTSS	15T.250B
8 x 1-1/2	8.1500TFTSS	15T.250B
8 x 2	8.200TFTSS *	15T.250B
10 x 1/2	10.500TFTSS	20T.250B
10 x 3/4	10.750TFTSS	20T.250B
10 x 1-1/4	10.12500TFTSS	20T.250B
10 x 1-1/2	10.1500TFTSS	20T.250B
10 x 2	10.200TFTSS	20T.250B
10 x 2-1/2	10.2500TFTSS *	20T.250B
10 x 3	10.300TFTSS *	20T.250B
12 x 3/4	12.750TFTSS	25T.250B
12 x 1	12.100TFTSS	25T.250B
12 x 1-1/4	12.1250TFTSS *	25T.250B
12 x 1-1/2	12.1500TFTSS	25T.250B
12 x 2	12.200TFTSS *	25T.250B
12 x 2-1/2	12.2500TFTSS *	25T.250B
12 x 3	12.300TFTSS *	25T.250B
14 x 1	14.100TFTSS	27T.250B
14 x 1-1/2	14.1500TFTSS	27T.250B
14 x 2	14.200TFTSS	27T.250B
14 x 2-1/2	14.2500TFTSS	27T.250B
14 x 3	14.300TFTSS	27T.250B

Everything you need: Technical support, custom solutions and timely delivery

QUESTIONS, QUOTES & SOLUTIONS: TOLL-FREE 1.888.584.6283 OR SALES@LPFAST.COM



LOSS PREVENTION FASTENERS & TOOLS[®]

STOPPING THEFT EVERY DAY.™

Call and speak to our security fastener specialists!

Toll Free 1.888.584.6238

Tamper Proof & Security HINGE SCREWS



Flat Head UnderCut

Hinge Screws heads are thin & countersunk

Ideal for securing hinges and all other thin materials

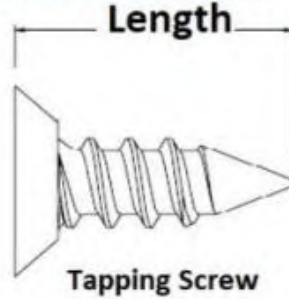
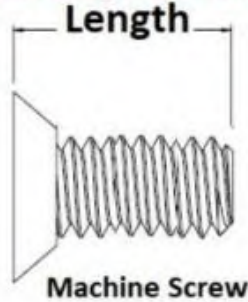
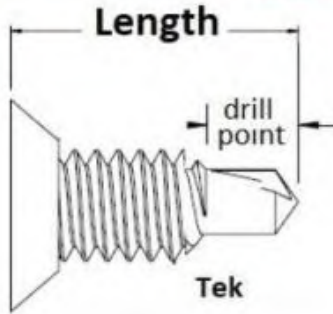

Flat Head UnderCut Machine Screws

Popular Flat Head Under-Cut sizes available



- 6-32 x various lengths, various materials
- 8-32 x various lengths, various materials
- 10-24 x various lengths, various materials
- 10-32 x various lengths, various materials
- 12-24 x various lengths, various materials
- 1/4-20 x various lengths, various materials
- 1/4-28 x various lengths, various materials
- 5/16-18 x various lengths, various materials
- 3/8-16 x various lengths, various materials

Metric Sizes available min quantities may apply

Universal Security Screw Drivers

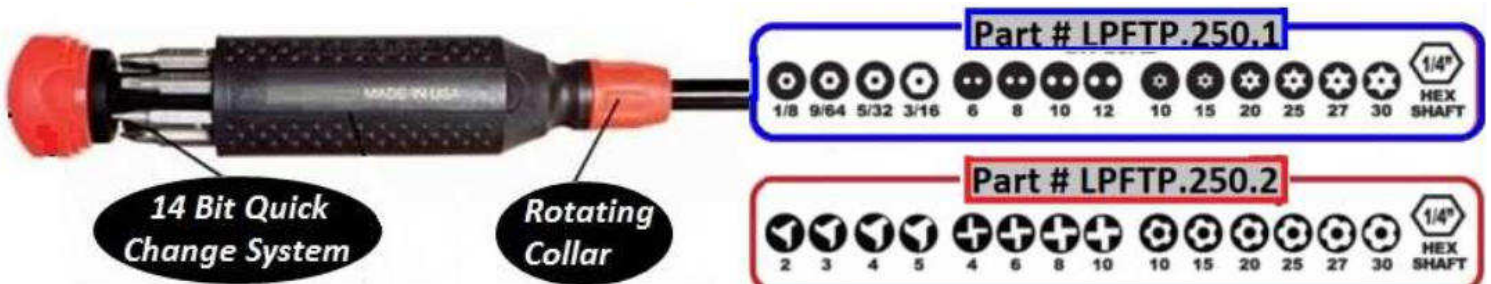

14 Bit Quick Change System

Rotating Collar

Part # LPFTP.250.1

- 1/8 9/64 5/32 3/16 6 8 10 12 10 15 20 25 27 30 1/4" HEX SHAFT

Part # LPFTP.250.2

- 2 3 4 5 4 6 8 10 10 15 20 25 27 30 1/4" HEX SHAFT



LOSS PREVENTION FASTENERS & TOOLS[®]

div of Ultra Fasteners Inc

www.LPfast.com

PH 1.888.584.6283



LOSS PREVENTION

FASTENERS & TOOLS®

STOPPING THEFT EVERY DAY.™



ULTRA 6 LOBE TYPE F POINT THREAD-CUTTING SCREW

THREAD-MAKING SCREWS

TYPE F and Thread Cutting

Ask about METRIC sizes CASE-HARDENED STEEL | STEEL | ZINC PLATED

FLAT HEAD



Security pin



Ultra 6 Lobe

Type F

BUTTON HEAD



Type F

TYPE F POINT:

- A thread-cutting screw with a blunt tapered point
- Multiple cutting edges and chip cavities
- Use in heavy gauge sheet metal, aluminum, zinc and lead casting, cast iron, brass and plastic

Button Head PART NUMBER	Steel, Zinc Plated SIZE TYPE F *	TOOL NUMBER
832.500TBZF 832.750TBZF 832.100TBZF	8-32 x 1/2" 8-32 x 3/4" 8-32 x 1"	15T.250B
1024.375TBZF 1024.625TBZF 1024.100TBZF	10-24 x 3/8" 10-24 x 5/8" 10-24 x 1"	25T.250B
1032.500TBZF 1032.750TBZF	10-32 x 1/2" 10-32 x 3/4"	25T.250B
1420.750TBZF 1420.100TBZF 1420.1500TBZF	1/4"-20 x 3/4" 1/4"-20 x 1" 1/4"-20 x 1-1/2"	27T.250B

Minimum quantities may apply. Stainless Steel available as made to order.
Ask about High Security options. Special sizes and custom sizes are welcome.

Security THREAD-MAKING Security Options Vary by Type & Size

INCH & METRIC SIZES | VARIOUS MATERIALS | MINIMUM QUANTITIES APPLY

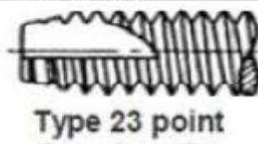
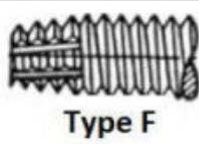
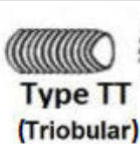

inquire about other thread forming options

SIZE	DESCRIPTION	HEAD	SECURITY	MATERIAL	PART #
8-32 x 1-1/4	TEK Thread Cutting	Oval	6 Lobe Pin	Steel, plain	832.125TOT
8-32 x 1	Type 23 Thread Cutting	Oval	6 Lobe Pin	Steel Zinc Plated	832.100TOZ23
8-32 x 1-1/2	TEK Thread Cutting	Oval	6 Lobe Pin	Steel Zinc Plated	832.1500TOZT
1/4-20 x 1/2	Type 23 Thread Cutting	Flat	6 Lobe Pin	Steel Zinc Plated	1420.500TFZ23
1/4-20 x 3/4	Type 23 Thread Cutting	Button	6 Lobe Pin	Steel Zinc Plated	1420.750TBZ23
1/4-20 x 1	Type 23 Thread Cutting	Button	6 Lobe Pin	Steel Zinc Plated	1420.100TBZ23
1/4-20 x 3/4	Type TT Thread Cutting	Truss	6 Lobe Pin	Steel Zinc Plated	1420.750TTZTO
1/4-20 x 1	Type TT Thread Cutting	Truss	6 Lobe Pin	Steel Zinc Plated	1420.100TTZTO
1/4-20 x 1-1/2	Type TT Thread Cutting	Truss	6 Lobe Pin	Steel Zinc Plated	1420.1500TTZTO
1/4-28 x 3/4	TEK Thread Cutting	Button	6 Lobe Pin	Steel Zinc Plated	1428.750TBTZ
1/4-28 x 1-1/4	TEK Thread Cutting	Button	6 Lobe Pin	Steel Zinc Plated	1428.1250TBTZ
1/4-28 x 1-1/2	TEK Thread Cutting	Button	6 Lobe Pin	Steel Zinc Plated	1428.1500TBTZ
1/4-28 x 3/4	Type 23 Thread Cutting	Button	6 Lobe Pin	Steel Zinc Plated	1428.752TBZ23

Everything you need: Technical support, custom solutions and timely delivery

QUESTIONS, QUOTES & SOLUTIONS: TOLL-FREE 1.888.584.6283 OR SALES@LPFAST.COM



Stainless Steel

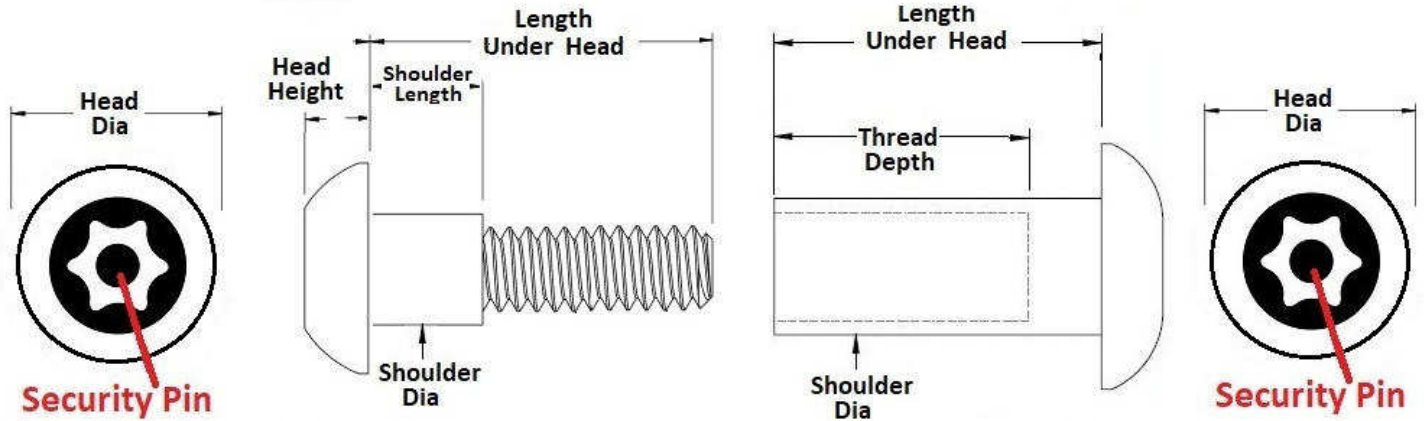

Tool PART # 27T.250B

Tool PART # 27T.250B

Female Security Barrel Nut, Various Lengths

additional lengths available
MCQ may apply

Head Dia	Head Height	Shoulder Dia	Length Under Head	Thread Depth	Screw Thread	Part Number
± 0.008	± 0.011	± 0.004	± 0.01	± 0.02		
0.425"	0.125"	0.245"	0.500"	0.377"	10-24	250.500TBNSS
0.425"	0.125"	0.245"	0.625"	0.500"	10-24	250.625TBNSS
0.425"	0.125"	0.245"	0.750"	0.500"	10-24	250.750TBNSS

not exactly as shown



Male & Female sold separately

minimum quantities may apply

minimum quantities may apply

Male Security Screw with Shoulder Various Lengths

Head Dia	Head Height	Shoulder Dia	Length Under Head	Shoulder Length	Screw Thread	Part Number
± 0.008	± 0.008	± 0.003	including shoulder	± 0.008		
0.425"	0.125"	0.236"	3/4"	0.248"	10-24	1024.750TBSCSS
0.425"	0.125"	0.236"	15/16"	0.248"	10-24	1024.9375TBSCSS
0.425"	0.125"	0.236"	1-1/16"	0.248"	10-24	1024.1062TBSCSS
0.425"	0.125"	0.236"	1-3/16"	0.248"	10-24	1024.1187TBSCSS
0.425"	0.125"	0.236"	1-5/16"	0.248"	10-24	1024.1312TBSCSS
0.425"	0.125"	0.236"	1-3/8"	0.248"	10-24	1024.1375TBSCSS

not exactly as shown



Everything you need: Technical support, custom solutions and timely delivery

QUESTIONS, QUOTES & SOLUTIONS: TOLL-FREE 1.888.584.6283 OR SALES@LPFAST.COM

Female Security Barrel Nut aka Sex Nut

Male Screw

Total Thickness of materials



Security Pin



18.8 Stainless



(screws Not Included)

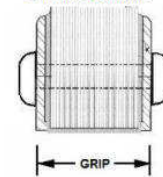

6 Lobe Tamperproof Security—Female Barrels

18-8 ST/ST

Barrel Diameter	Barrel Length +/-	Thread Size	Thread Depth +/-	Head Diameter +/-	Number	Tool #
1/4"	3/8"	10-24	1/4"	7/16"	250.375TBNSS	30T.250B
	1/2	10-24	1/4"	7/16	250.500TBNSS	
	5/8	10-24	1/4"	7/16	250.625TBNSS	
	3/4	10-24	3/8	7/16	250.750TBNSS	
	1	10-24	3/8	7/16	250.100TBNSS	
	1-1/4	10-24	3/8	7/16	250.1250TBNSS	
	1-1/2	10-24	3/8	7/16	250.1500TBNSS	
5/16"	1/2	1/4-20	1/4	9/16	3125.500TBNSS	30T.250B
	3/4	1/4-20	3/8	9/16	3125.750TBNSS	
	1	1/4-20	3/8	9/16	3125.100TBNSS	
	1-1/4	1/4-20	3/8	9/16	3125.1250TBNSS	
	1-1/2	1/4-20	3/8	9/16	3125.1500TBNSS	
3/8"	3/4	5/16-18	1/2	.650"	316.750TBNSS	45T.250B
1/2"	1-1/4	3/8-16	3/4	.865"	500.1250TBNSS	55T.250B
5/8"	1-1/2	1/2-13	7/8	.865"	625.1500TBNSS	55T.250B
3/4"	1-1/2	5/8-11	1"		750.1500TBNSS	55T.3125B

Female Post, Button Head, 6 Lobe Pin, Stainless Steel



Flat head sizes available, please inquire

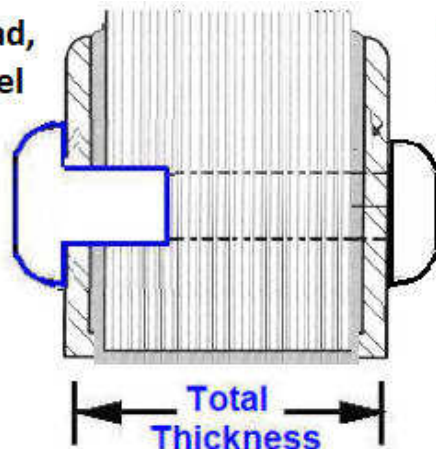

Male Screw, Button Head, 6 Lobe Pin, Stainless Steel



Male Screws Sold Separately

Now You Know: A long female barrel with a short male screw is the same as a short female barrel with a long male screw

T-GROOVE™ NUTS SECURITY FASTENER



LOSS PREVENTION

FASTENERS & TOOLS®

div of Ultra Fasteners Inc www.LPfast.com PH 1.888.584.6283

INCH SIZES (metric sizes next page)



Superb security fastener:

- No sharp edges
- 316 stainless
- Design prevents pooling of liquids and debris
- Rated to 2450 degrees F

MADE IN

Produced from US-made/melted stainless steel

Tools LPF420, LPF430, LPF440

Multi Use: Use standard socket drive OR open end wrench for tight fit OR deep socket over the end for long studs

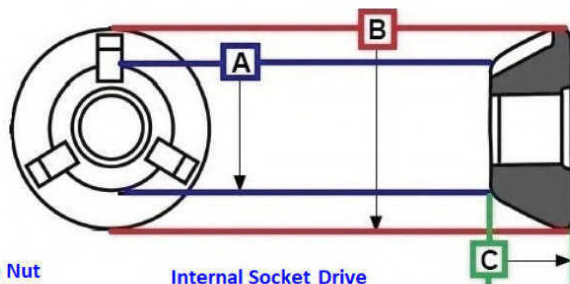

T-Groove Nut
Excellent Tool
Engagement

Internal Socket Drive
Open End Wrench option
Deep Socket option



LPF420, LPF430, LPF440,

LPF475

FITS	NUT SIZE *	PART NUMBER *	SOCKET PART NUMBER	TOP DIAMETER A	BOTTOM DIAMETER B	HEIGHT RANGE C
UNC	10-24	1024.TGNSS	LPF420	.446	.661	.260
UNF	10-32	1032.TGNSS	LPF420	.446	.661	.260
UNC	1/4-20	1420.TGNSS	LPF420	.446	.661	.260
UNF	1/4-28	1428.TGNSS	LPF420	.446	.661	.260
UNC	5/16-18	518.TGNSS	LPF430	.542	.830	.340
GALV	5/16-18	518TGNSSOT	LPF430	.542	.830	.340
UNF	5/16-24	524.TGNSS	LPF430	.542	.830	.340
UNC	3/8-16	316.TGNSS	LPF430	.542	.830	.340
UNF	3/8-24	324TGNSS	LPF430	.542	.830	.340
GALV	3/8-16	316.TGNSSOT	LPF430	.542	.830	.340
UNC	7/16-14	714.TGNSS	LPF430	.542	.830	.340
UNF	7/16-20	720.TGNSS	LPF430	.542	.830	.340
UNC	1/2-13	113.TGNSS	LPF440	.662	.945	.345
UNF	1/2-20	120.TGNSS	LPF440	.662	.945	.345
GALV	1/2-13	113.TGNSSOT	LPF440	.662	.945	.345
UNC	5/8-11	511.TGNSS	LPF475	1.000	1.500	.475
UNF	5/8-16	516.TGNSS	LPF475	1.000	1.500	.475
GALV	5/8-11	511.TGNSSOT	LPF475	1.000	1.500	.475
UNC	3/4-10	310.TGNSS	LPF475	1.000	1.500	.475
UNF	3/4-16	343.TGNSS	LPF475	1.000	1.500	.475
GALV	3/4-10	310.TGNSSOT	LPF475	1.000	1.500	.475

Measurements +/-

Metric T-Groove Security Nuts next page

Jan 2021

STOPPING THEFT EVERY DAY.™

T-GROOVE™ NUTS SECURITY FASTENER



METRIC SIZES (inch sizes previous page)

T-Groove Screws & T-Groove Tools: See Page 10



Superb security fastener:

- No sharp edges
- 316 stainless
- Design prevents pooling of liquids and debris
- Rated to 2450 degrees F

MADE IN

Produced from US-made/melted stainless steel

Tools LPF420, LPF430, LPF440

Multi Use: Use standard socket drive OR open end wrench for tight fit OR deep socket over the end for long studs

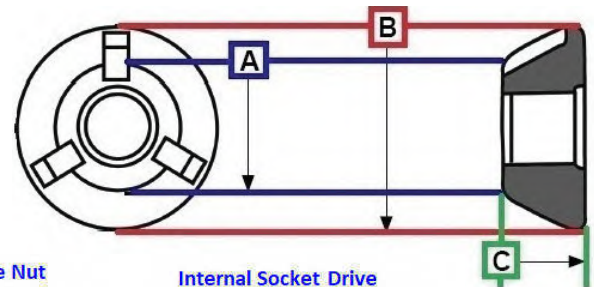

T-Groove Nut
Excellent Tool
Engagement

Internal Socket Drive
Open End Wrench option
Deep Socket option



LPF420, LPF430, LPF440,

LPF475

FITS	NUT SIZE *	PART NUMBER *	SOCKET PART NUMBER	TOP DIAMETER A	BOTTOM DIAMETER B	HEIGHT RANGE C
Metric	M5 x 0.8	M5.TGNSS	LPF420	12.3mm	16.7mm	6.7mm
Metric	M6 x 1.0	M6.TGNSS	LPF420	12.3mm	16.7mm	6.7mm
Metric	M8 x 1.25	M8.TGNSS	LPF430	14.1mm	21mm	8.9mm
Metric	M8 x 1.0 fine	M810.TGNSS	LPF430	14.1mm	21mm	8.9mm
Metric	M10 x 1.5	M10.TGNSS	LPF430	14.1mm	21mm	8.9mm
Metric	M10 x 1.25	M10125.TGNSS	LPF430	14.1mm	21mm	8.9mm
Metric	M12 x 1.75	M12.TGNSS	LPF440	17.2mm	24mm	8.9mm
Metric	M12 x 1.5	M1215.TGNSS	LPF440	17.2mm	24mm	8.9mm
Metric	M14.TGNSS	M14 X 2.0	LPF475	17.2mm	24mm	8.9mm
Metric	M16.TGNSS	M16 X 2.0	LPF475	26.3mm	38.4mm	12.8mm
Metric	M18.TGNSS	M18 x 2.5	LPF475	26.3mm	38.4mm	12.8mm
Metric	M1815.TGNSS	M18 x 1.5	LPF475	26.3mm	38.4mm	12.8mm
Metric	M20 X 2.5	M20 x 2.5	LPF475	26.3mm	38.4mm	12.8mm

* ITEMS IN RED ARE FINE THREAD

Measurements +/-

[INCH T-Groove Security Nuts previous page](#)

STOPPING THEFT EVERY DAY.™

T-GROOVE™ NUTS SECURITY FASTENER



LOSS PREVENTION

FASTENERS & TOOLS®

div of Ultra Fasteners Inc www.LPfast.com PH 1.888.584.6283

Steel, Zinc Plated

Stainless Steel on the previous pages



Multi Use Security Fastener:

- No sharp edges
- Design prevents pooling of liquids and debris

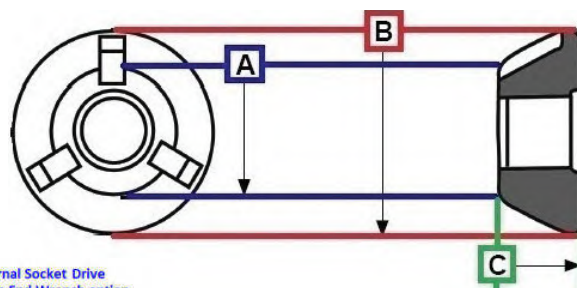

T-Groove Nut
Excellent Tool
Engagement

Internal Socket Drive
Open End Wrench option
Deep Socket option

MADE IN

Produced from US-made/melted steel



FITS	NUT SIZE *	PART NUMBER *	SOCKET PART NUMBER	TOP DIAMETER A	BOTTOM DIAMETER B	HEIGHT RANGE C
UNC	10-24	1024.TGN	LPF420	.446	.661	.260
UNF	10-32	1032.TGN	LPF420	.446	.661	.260
UNC	1/4-20	1420.TGN	LPF420	.446	.661	.260
UNC	5/16-18	518.TGN	LPF430	.542	.830	.340
GALV	5/16-18	518.TGN OT	LPF430	.542	.830	.340
UNC	3/8-16	316.TGN	LPF430	.542	.830	.340
GALV	3/8-16	316.TGN OT	LPF430	.542	.830	.340
UNC	1/2-13	113.TGN	LPF440	.662	.945	.345
GALV	1/2-13	113.TGN OT	LPF440	.662	.945	.345
UNC	5/8-11	511.TGN	LPF475	1.000	1.500	.475
GALV	5/8-11	511.TGN OT	LPF475	1.000	1.500	.475
UNC	3/4-10	310.TGN	LPF475	1.000	1.500	.475
GALV	3/4-10	310.TGN OT	LPF475	1.000	1.500	.475

Minimum quantities may apply. Ask about sizes not listed. Ask about special finishes

m5 x 0.8	M5.TGN	LPF420	.446	.661	.260
m6 x 1.0	M6.TGN	LPF420	.446	.661	.260
m8 x 1.25	M8.TGN	LPF430	.542	.830	.340
m10 x 1.5	M10.TGN	LPF430	.542	.830	.340
m12 x 1.75	M12.TGN	LPF440	.662	.945	.345
m16 x 2.0	M16.TGN	LPF475	1.000	1.500	.475
m20 x 2.5	M20.TGN	LPF475	1.000	1.500	.475

Measurements +/-

Minimum quantities may apply. Ask about sizes not listed. Ask about special finishes

STOPPING THEFT EVERY DAY.™

T-Groove Tools for all sizes of T-Groove Nuts & Screws

Tri-Groove, Trident, Tampruf etc

The most versatile T-Groove socket in the world!

Standard Socket



4 Flats allows use of open end wrench and/or 12 point socket over the end

Deep Socket 2-1/2"



YES!
We have all sizes of the nuts

—All Sockets made of Steel. Black Oxide finish—

DEEP/LONG REACH T-Groove Socket

overall length 2-1/2"

Hard to reach & long studs

PART No.	Description	Fits Sizes
LPF420 3/8 drive	Standard Socket 1-1/4" socket length,	10-24,10-32, 1/4-20, 1/4-28, 5mm, 6mm 3/4" socket O.D.
LPF420.2 3/8 drive	Deep Socket/Long Reach 2-1/2" Socket Length approx 2" of throw	10-24,10-32, 1/4-20, 1/4-28, 5mm, 6mm 3/4" socket O.D.
LPF430 3/8 drive	Standard Socket 1-1/4" socket length	5/16, 3/8, 7/16 m8, m10 .980" socket O.D.
LPF430.2 3/8 drive	Deep Socket/Long Reach 2-1/2" Socket Length approx 2" of throw	5/16, 3/8, 7/16 m8, m10 .980" socket O.D.
LPF440 1/2 drive	Standard Socket 1-1/4" socket length	1/2-13, 1/2-20, M12, M14 1.25" socket O.D.
LPF440.2 1/2 drive	Deep Socket/Long Reach 2-1/2" Socket Length approx 2" of throw	1/2-13, 1/2-20, M12, M14 1.25" socket O.D.
LPF475	Universal Socket Deep socket style 2" socket length	5/8, 3/4, m16, m18, m20 1.55" socket O.D.

TGBIT.AST

Holt Head Friendly



Set of 4 Bits, Fits all Sizes of T-Groove Screws

(not compatible with T-Groove Nuts)

YES! We have T-Groove Screws



LOSS PREVENTION
FASTENERS & TOOLS[®]

div of Ultra Fasteners Inc

www.LPfast.com

PH 1.888.584.6283

High Security Nuts

Stopping Theft Every Day™

LOSS PREVENTION
FASTENERS & TOOLS®



Excellent Tool Engagement

Unique S7 Drive System

Resists Gripping Tools

Made in USA

316 Stainless Steel

Made in USA
Patented
High Security
316 Stainless

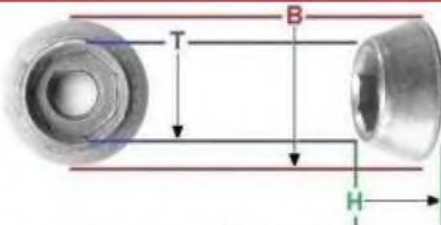

Ultra-Lok S7 Deep Socket

Size	Part #	Material	TOP DIAM. T	BOTTOM DIAM. B	HEIGHT H	Deep Socket Tool #
3/8-16	316.ULS7SS	316SS	0.73"	1.00"	0.378"	375.S7B
3/8-16	316.ULS7SSOT <small>Galvanized Compatible</small>	316SS	0.73"	1.00"	0.378"	375.S7B
1/2-13	113.ULS7SS	316SS	.94"	1.25"	.50"	500.S7B
1/2-13	113.ULS7SSOT <small>Galvanized Compatible</small>	316SS	.94"	1.25"	.50"	500.S7B

SLOT-LOK High Security

On/Off with controlled tool.

Slot-Lok Is ideal for industry that requires hygienic/cleanliness as there are no cavities that fill with debris.



After installation Slot-Lok can be removed with the tools.

The tools are not available in any stores, the tools are not sold to the public.

Slot-Lok does not invite interference as it 'hides in plain sight'; it does not look like a typical fastener.

Stainless Steel tough, hygienic & high security

Inch & Metric Size
Various Materials



LOSS PREVENTION
FASTENERS & TOOLS®
STOPPING THEFT EVERY DAY.™

Call and speak to our security fastener specialists!

Toll Free 1.888.584.6238

Tork-Bolts™

Break Off Bolts

M Series

- HIGH SECURITY, PERMANENT FASTENER
- NO SPECIAL TOOLS REQUIRED
- BUTTON OR COUNTERSUNK HEAD
- ALL MATERIALS AVAILABLE
- INCH, METRIC & CUSTOM SIZES



Flat head

Button Head



Non Removable *after* Installation

Call and check stock... many sizes on the shelf

Stocking Common Sizes / Manufacturing All Sizes, Materials & Designs

Tork Bolts, Inch & Metric Sizes, Various Materials
ask about our "Double Hex Head" Tork Bolts

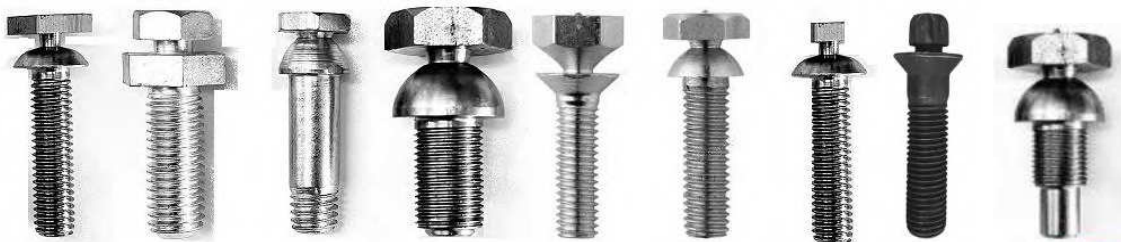

Custom, non standard & special sizes are our specialty

Everything you need: Technical support, custom solutions and timely delivery

QUESTIONS, QUOTES & SOLUTIONS: TOLL-FREE 1.888.584.6283 OR SALES@LPFAST.COM



LOSS PREVENTION
FASTENERS & TOOLS®
STOPPING THEFT EVERY DAY.™

Call and speak to our security fastener specialists!

Call for sizes & lengths

TOGGLE SECURITY



Nom. Size	THREAD SIZE	Wing width	Folded Wing Length	required Hole Size
1/8"	6-32	1-1/2"	7/8"	3/8"
3/16"	10-24	2-1/8"	1-1/4"	1/2"
1/4"	1/4-20	2-1/8"	1-1/4"	5/8"
5/16"	5/16-18	2-5/8"	1-1/2"	7/8"
3/8"	3/8-16	3"	1-3/4"	7/8"
1/2"	1/2-13	4"-3/4"	2-3/4"	1-1/4"

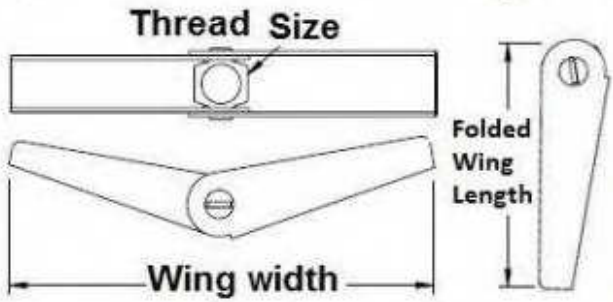
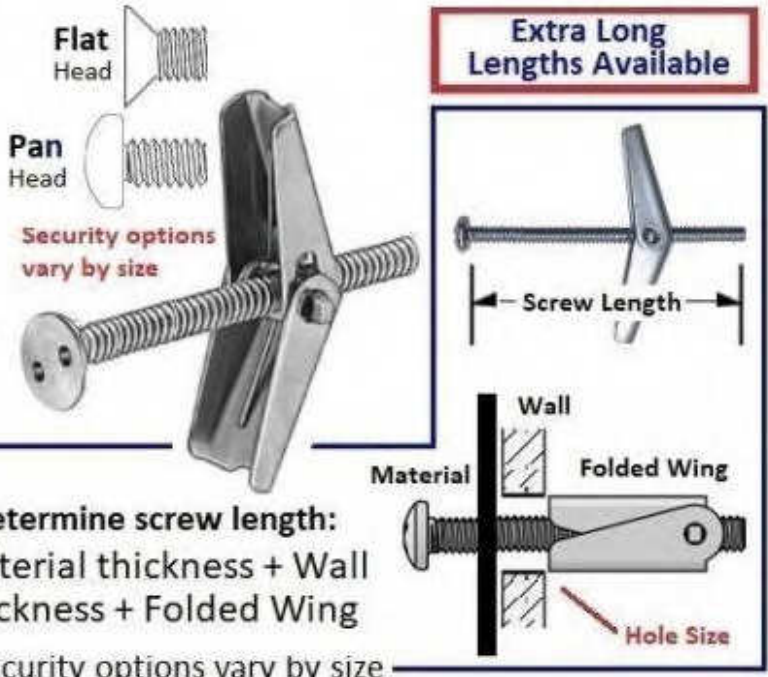

Determine screw length:
 Material thickness + Wall Thickness + Folded Wing
 Security options vary by size.

Cut sheets and tech sheets available

Custom, Non Standard & Special Fasteners
 made to order, inch & metric, various materials



Security

minature to oversize

Non Security

sales@LPfast.com

Everything you need: Technical support, custom solutions and timely delivery

QUESTIONS, QUOTES & SOLUTIONS: TOLL-FREE 1.888.584.6283 OR SALES@LPFAST.COM



LOSS PREVENTION
FASTENERS & TOOLS®
STOPPING THEFT EVERY DAY.™



Phillips-Pin Security

See Page 3 for all options

Phillips-Pin security, tamper resistant and anti-theft available in 18.8 & 316 stainless steel



- Round Head, Flat Head, Undercut & more
- Inch & Metric Sizes, Various Materials
- Extra Long Length, Large Diameter
- Machine Screws & Tapping Screws, Made in USA

All sizes in available from stock, custom sizes made to order, low minimums

AVAILABLE IN INCH AND METRIC SIZES, LARGE DIAMETER & EXTRA LONG LENGTHS, MATERIALS, STYLES AND SHAPES

Call our Fastener Specialists
for immediate support

Slot-Lok High Security Restricted tool Program



Pan
Head

Unique Security Design

Hides in plain sight

Large Diameters Available

Up to 1-1/2" diameter

Various Materials

18.8 316 & more

Hygienic Design

No closed crevices to retain grime

Made to Order , 100 piece minimum
Extra large size may have less mins.

Slot-Lok Nuts also available Page 20

Everything you need: Technical support, custom solutions and timely delivery

QUESTIONS, QUOTES & SOLUTIONS: TOLL-FREE 1.888.584.6283 OR SALES@LPFAST.COM



LOSS PREVENTION
FASTENERS & TOOLS®
STOPPING THEFT EVERY DAY.™



HIGH SECURITY

Restricted Tool Program
Inch & Metric Sizes
minimum quantities may apply

Ultra-Lok



Ultra-Lok II



Ultra-Lok P



Tools not available to the public

Machine Screws

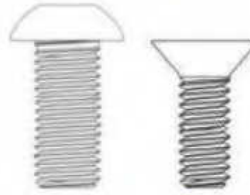

Button Flat

Tapping Screws



Flat Button

ROBY-PIN® HIGH SECURITY SCREWS

18.8 & 316 Stainless Steel Options

minimum quantities may apply

AVAILABLE IN INCH AND METRIC SIZES, STANDARD & CUSTOM LENGTHS

Tapping Screws, Wood screws, Machine screws & more



TAPPING SCREWS

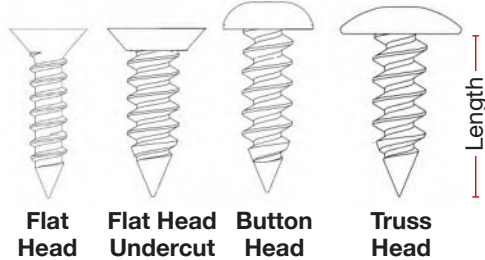

MACHINE SCREWS

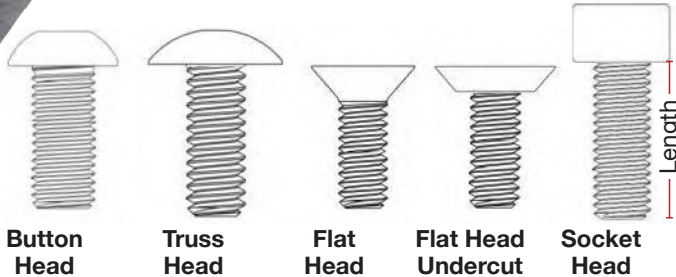

4 CORNER WITH PIN SECURITY SCREWS

Tools **NOT** available in hardware stores

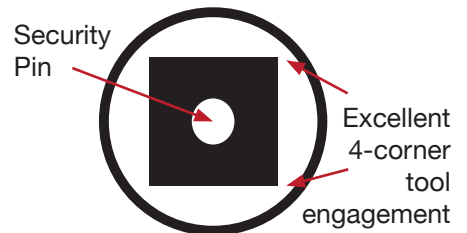

Call and speak to our security fastener specialists!

Minimum quantities may apply.

Everything you need: Technical support, custom solutions and timely delivery

QUESTIONS, QUOTES & SOLUTIONS: TOLL-FREE 1.888.584.6283 OR SALES@LPFAST.COM



LOSS PREVENTION
FASTENERS & TOOLS®
STOPPING THEFT EVERY DAY.™



ULTRA 5 LOBE™ HIGH SECURITY SCREWS

Tools not available in hardware stores

See Page 3 for all options

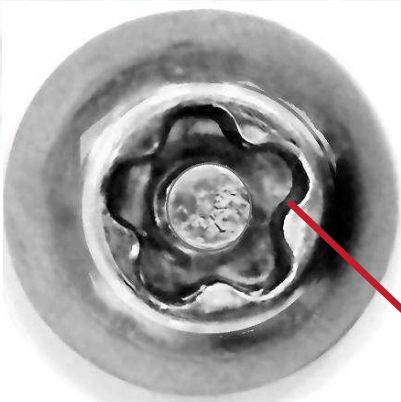

A high security, tamper resistant and anti-theft screw, with a unique design

- **Unique Head Design:** Makes them difficult to remove with conventional tools.
- **Enhanced Security:** A higher level of security, as tools aren't available in hardware stores.
- **Deterrence:** The presence of UNIQUE high security screw is a deterrence to prevent unauthorized access.

INCH & METRIC SIZES, *This is 5 Lobe Pin - not "6 Lobe" Pin type

ULTRA -LOK S7 EXCLUSIVE SECURITY SCREWS

Tools not available to the public

Nuts, Bolts & Screws & Tapping Screws & Drill Point Screws

Restricted Tool Program

A high security, tamper resistant and anti-theft screw, tools not available to the public.

INCH & METRIC SIZES,
See Page 3 for all options

Oversize security stud

High torque values

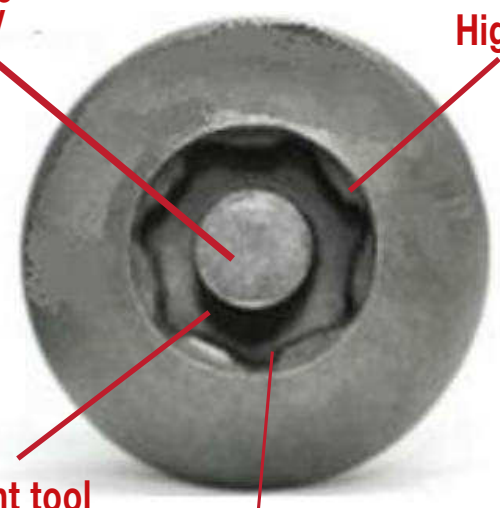

Excellent tool engagement

Unique S7 drive system

Minimum quantities may apply

Call and speak to our security fastener specialists!

Restricted Tool Program

Everything you need: Technical support, custom solutions and timely delivery

QUESTIONS, QUOTES & SOLUTIONS: TOLL-FREE 1.888.584.6283 OR SALES@LPFAST.COM

AVSAFE Oval-Pan Security Screws & Tools



LOSS PREVENTION
FASTENERS & TOOLS[®]
div of Ultra Fasteners Inc www.LPfast.com PH 1.888.584.6283

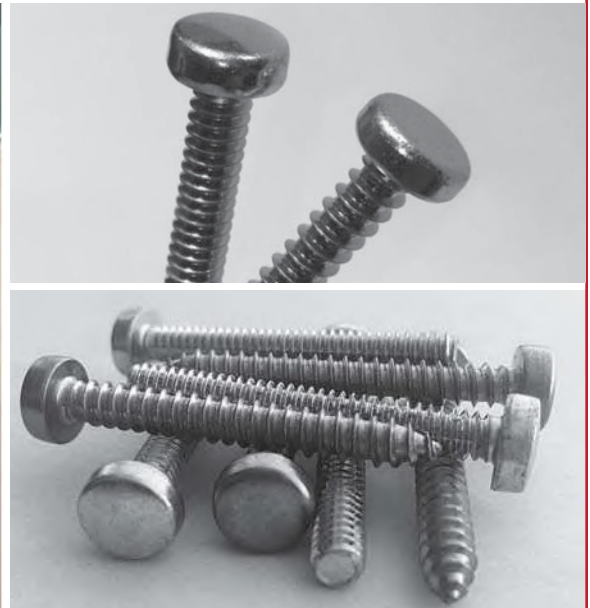
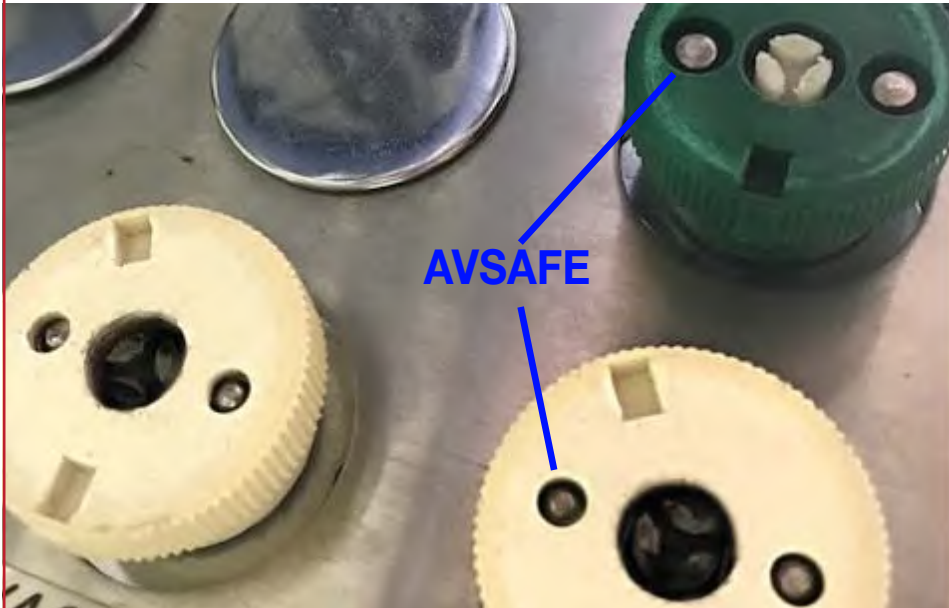

TAMPER-RESISTANT SECURITY FASTENERS THAT HIDE IN PLAIN SIGHT

High Security

- Oval-pan heads with beveled sides prevent removal with conventional tools. Install in a recess for utmost security.
- Can only be removed by tools exclusively manufactured in the USA by Ultra Fasteners – not available in hardware stores.
- Does not invite tampering as it appears to be an ornament rather than a fastener head.

Functional and Hygienic

- No flutes, recesses, holes or sharp edges.
- Ideal for medical and food-handling equipment – design prevents trapping of bacteria or food.
- Ideal for electronics – design prevents electron discharge.
- No sharp edges to snag clothing or cause injury.

Easy to Install

- Male-headed screws can be held in place by the screwdriver before entering the workpiece, simplifying their use even when access is limited.

Avsafe tools match the thread size: eg. #8 Avsafe screw & 8-32 Avsafe Screw use #8 Avsafe Tool
Avsafe tool size can also be determined by measuring the head.

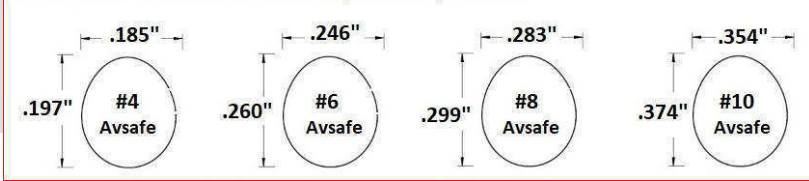

AVSAFE screwdriver
approx. 8" overall length



AVSAFE driver bit
(standard 1/4" hex)
approx. 2-3/4" overall length

TOOL SIZE	SCREWDRIVER PART NUMBER	DRIVER BIT PART NUMBER
4*	4AS.250SD	4AS.250B
6	6AS.250SD	6AS.250B
8	8AS.250SD	8AS.250B
10	10AS.250SD	10AS.250B

* Narrow barrel fits Med Gas

YES! We Sell Avsafe Screws INCH & METRIC SIZES

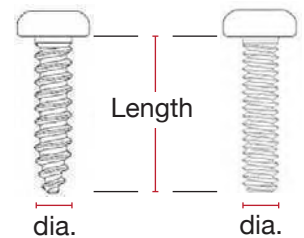

Tapping screw

Machine screw

Made in the USA

10/2018

STOPPING THEFT EVERY DAY.™



LOSS PREVENTION
FASTENERS & TOOLS®
STOPPING THEFT EVERY DAY.™



ULTRA 6 LOBE™ SECURITY SCREWS

See Page 3 for all options



An excellent security, tamper resistant and anti-theft screw, with a wide selection of sizes

- Excellent tool engagement
- Secure, aesthetically-pleasing safety design
- Quality domestic-made product  Made in the USA

Call and speak to our security fastener specialists!

All sizes in available from stock, custom sizes made to order, low minimums

Hex-Pin Security

See Page 3 for all options



Versatile security, tamper resistant and anti-theft available in 18.8 & 316 stainless steel A2 & A4

Alloy Steel Various Grades minimum quantities may apply for special sizes & materials

- Button Head, Flat Head, Shoulder Bolts, Set Screws & more
- Inch & Metric Sizes, Various Materials
- Extra Long Length, Large Diameter
- Made in USA 

All sizes in available from stock, custom sizes made to order, low minimums

AVAILABLE IN INCH AND METRIC SIZES, LARGE DIAMETER & EXTRA LONG LENGTHS, MATERIALS, STYLES AND SHAPES

Call our Fastener Specialists for immediate support

Everything you need: Technical support, custom solutions and timely delivery

QUESTIONS, QUOTES & SOLUTIONS: TOLL-FREE 1.888.584.6283 OR SALES@LPFAST.COM



LOSS PREVENTION
FASTENERS & TOOLS®
STOPPING THEFT EVERY DAY.™

Call our Fastener Specialists
 for immediate support

One-Way Round Security

- Machine Screws
- Tapping Screws
- Lag Screws



Countersunk
aka Oval Head



Round Head
Truss Head



One Way Removal Tools

SCREW DIA	Fits Head Dia	Tool Part #
#6	.224"	OWRB.6
#8	.260"	OWRB.8
#10	.339"	OWRB.10
#12	.392"	OWRB.12

Construction Security Lag Screws

Install/ Remove Tool # OWRB.18 ask about 6"

5/16 x 1-1/2 Part # 516.15001WL	5/16 x 2 Part # 516.2001WL	5/16 x 3 Part # 516.3001WL	5/16 x 4 Part # 516.2001WL
------------------------------------	-------------------------------	-------------------------------	-------------------------------

SCREW DIA	Fits Head Dia	Tool Part #
#14	.443"	OWRB.14
#15	.570"	OWRB.15
#16	.665"	OWRB.16
#18-20	.684"	OWRB.18

Spanner, Snake Eye, Pig Nose

Spanner (snake eyes) security, tamper resistant and anti-theft

See Page 3 for all options **available in various materials*** *min qty may apply



- Pan Head, Flat Head, Oval Head & Truss Head
- Inch & Metric Sizes, Various Materials
- Extra Long Lengths available
- Machine Screws & Tapping Screws

See page 42 for install/removal tools

All sizes in available from stock, custom sizes made to order, low minimums

Everything you need: Technical support, custom solutions and timely delivery

QUESTIONS, QUOTES & SOLUTIONS: TOLL-FREE 1.888.584.6283 OR SALES@LPFAST.COM



LOSS PREVENTION
FASTENERS & TOOLS®
STOPPING THEFT EVERY DAY.™

Call and speak to our security fastener specialists!
Toll Free 1.888.584.6238

CAPTIVE PANEL SCREW SECURITY Stainless

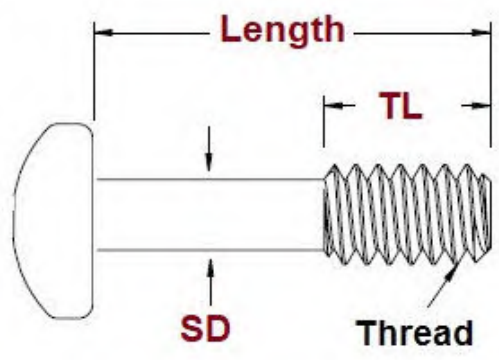
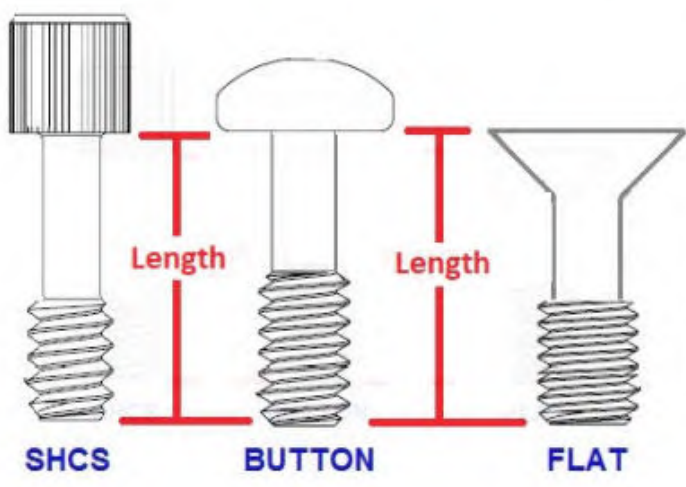

security options limited by size

minimum quantity may apply

SECURITY SEALING SCREWS INCH & METRIC SIZES

Various Styles 6 Lobe Pin, 5 Lobe Pin, Hex Pin, T-Groove, Slot-lok
Button Head, Pan Head, Socket Head, T-Groove, Slot-Lok

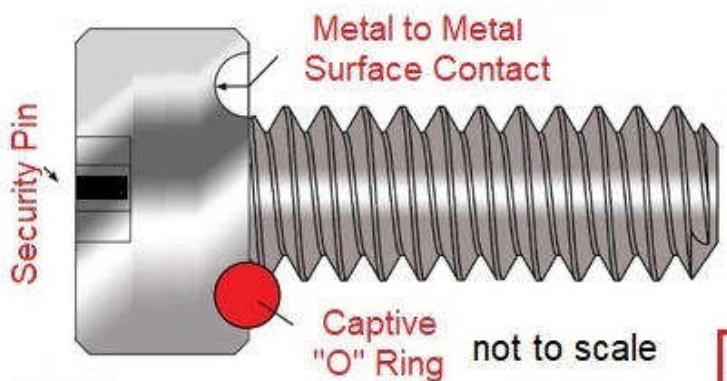

not exactly as shown



"O" ring provides 360 of protection with Metal-to-metal contact

Made in USA

18.8 stainless steel

See Page 3 for all options

Everything you need: Technical support, custom solutions and timely delivery
QUESTIONS, QUOTES & SOLUTIONS: TOLL-FREE 1.888.584.6238 OR SALES@LPFAST.COM



LOSS PREVENTION
FASTENERS & TOOLS®
STOPPING THEFT EVERY DAY.™

Call and speak to our security fastener specialists!

Toll Free 1.888.584.6238

HEX-PIN SET SCREWS

INCH & METRIC

A wide variety of sizes on the shelf



CUP

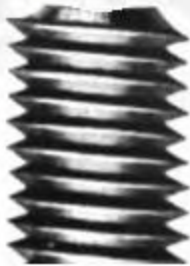

CONE



OVAL



DOG



FLAT



Call our Fastener Specialists for immediate support

Ask about 6 Lobe Pin (min qty may apply)

SOCKET HEAD CAP-SCREWS

INCH & METRIC

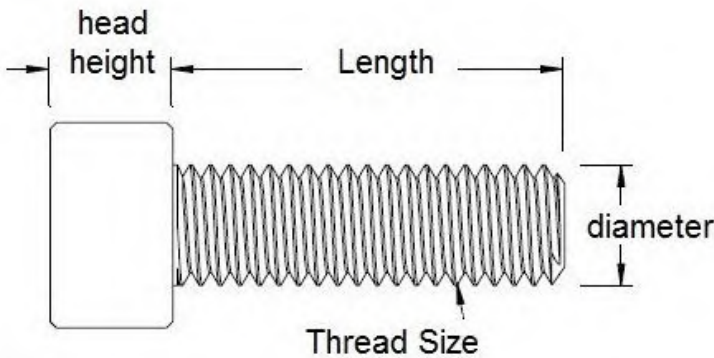

Hex-Pin Security

SHOULDER BOLT SECURITY

INCH & METRIC

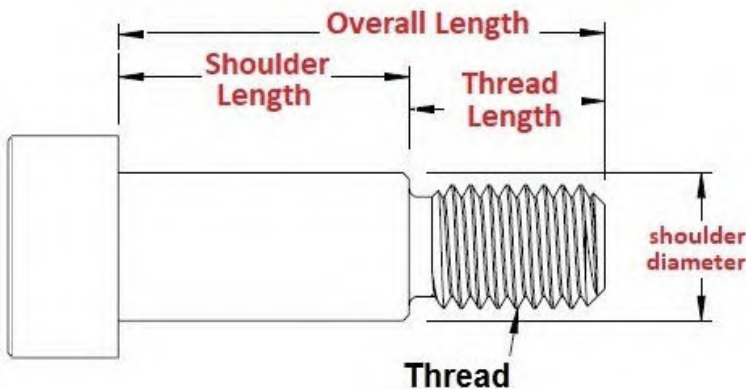

Hex-Pin Security

Everything you need: Technical support, custom solutions and timely delivery

QUESTIONS, QUOTES & SOLUTIONS: TOLL-FREE 1.888.584.6283 OR SALES@LPFAST.COM



LOSS PREVENTION
FASTENERS & TOOLS®
STOPPING THEFT EVERY DAY.™

Call and speak to our security fastener specialists!

Toll Free 1.888.584.6238

T-Groove Screws



PART # TGBIT.AST

**T-GROOVE
SCREW DRIVER BITS**

**Removes Screws:
#4, #6, #8, #10, #14**



Holt Head friendly

All sizes in available from stock, custom sizes made to order, low minimums

Custom, non standard & special sizes are our specialty

316 Stainless

**Security
Screws**

Excellent security, tamper resistant and anti-theft screw, available in 316 & 18.8 stainless steel A4

**316
Stainless
Steel
Security**

- Inch & Metric Sizes
- Made in USA
- Coarse & Fine Thread Pitch, various diameters
- Ask about Special Threads & Heads Styles
- Minimum quantities may apply - call and check stock

See page 3 & 5 for all options

Everything you need: Technical support, custom solutions and timely delivery

QUESTIONS, QUOTES & SOLUTIONS: TOLL-FREE 1.888.584.6283 OR SALES@LPFAST.COM



LOSS PREVENTION
FASTENERS & TOOLS®
STOPPING THEFT EVERY DAY.™

Call our Fastener Specialists
for immediate support

Electrical Panel Security Screws

Replace these
Schneider 4020513002K

cover trim screw,
10-32, 3/4" length

Stainless Steel
Tools Not Available
in Hardware Stores
"NON STANDARD SECURITY"
Made in USA

PART # 1032.750RTSS Tool # 2RP.250B
Desc: 10-32 x 3/4 Roby Pin Large hd SS

Security Pin
Unique 4 Lobe

Tools Not in Hardware Stores

PART # 1032.TTPSS Tool # 5LPD.250B
Desc: 10-32 x 3/4 Ultra 5Lobe Pin Large hd SS

Security Pin
Unique 5 Lobe

Tools Not in Hardware Stores

Plug & Switch Plate Security Screws

Fits all standard
switch & plug covers

High Security screws

White
Ivory
Stainless

Oval head



6-32
Thread

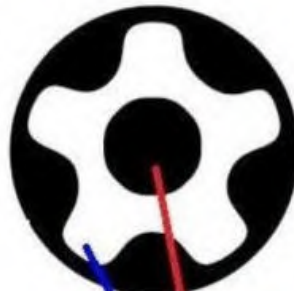

Security Pin
Unique 5 Lobe



5 Lobe Pin
Tools Not Available
in Hardware Stores

Everything you need: Technical support, custom solutions and timely delivery

QUESTIONS, QUOTES & SOLUTIONS: TOLL-FREE 1.888.584.6283 OR SALES@LPFAST.COM



LOSS PREVENTION
FASTENERS & TOOLS®
STOPPING THEFT EVERY DAY.™

Call and speak to our security fastener specialists!

Toll Free 1.888.584.6238

SECURITY PIN SHACKLE

PART # 3125.500DSSS
 5/16" dia Stainless

PART # 3125.500DSG
 5/16" dia Galvanized



Safety First. No More "S" Hooks

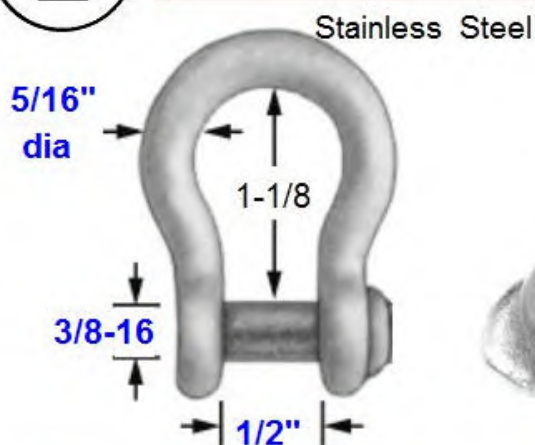

DOUBLE SHACKLE SECURITY PIN

Small & Large Opening - No More "S" Hooks - Re-Usable

PART #3816.DSCSS
 Stainless Steel



PART #3816.DSCG
 Galvanized Steel



Everything you need: Technical support, custom solutions and timely delivery

QUESTIONS, QUOTES & SOLUTIONS: TOLL-FREE 1.888.584.6283 OR SALES@LPFAST.COM

Security Pin Bolt Rivets

Stop Sign Theft

ideal for installing material onto thin metals, hollow tube, and wood

non rusting aluminum

install with a hammer

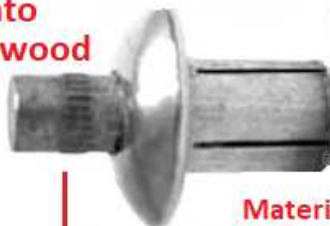
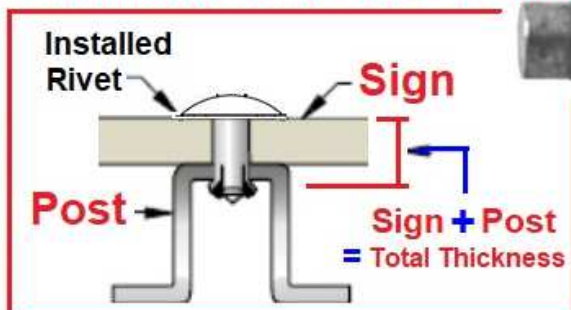

min	Material Thickness Range	max	Length	Part #
.125"	.188"	.250"	.500"	375.188TPRA
.219"	.281"	.344"	.594"	375.281TPRA
.313"	.375"	.438"	.688"	375.375TPRA
.406"	.469"	.531"	.791"	375.469TPRA
.500"	.536"	.625"	.875"	375.563TPRA
.594"	.565"	.719"	.968"	375.656TPRA
.688"	.750"	.813"	1.063"	375.750TPRA
.781"	.844"	.906"	1.156"	375.844TPRA
.875"	.938"	1.000"	1.250"	375.938TPRA
.969"	1.031"	1.094"	1.344"	375.1031TPRA

Aluminum Security Rivets

Tamper Proof Rivet Aluminum



Heavy Duty Aluminum



**Vibration Resistant
Tamper Resistant**
Works well with round posts!

Need to occasionally change the sign: Ask us about removable security using special tools.

TPRA can also be installed into wood: Drill a 3/8" hole place TPRA thru sign, into wood and hammer the pin.



LOSS PREVENTION

FASTENERS & TOOLS

div of Ultra Fasteners Inc

www.LPfast.com

PH 1.888.584.6283



LOSS PREVENTION
FASTENERS & TOOLS[®]
STOPPING THEFT EVERY DAY.[™]



STOP SIGN THEFT

Your Choice of Security Nut

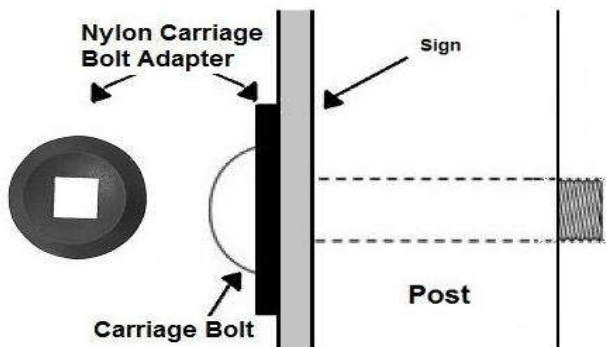

Tork Nut
 permanent security



Aluminum or Stainless

T-41 Slope Nut



Steel Yellow Zinc

T-Groove



Stainless Steel Removable with the special tool

T-41 Slope Nuts

Weather Resistant Yellow Dichromate



INCH	
SIZE	PART No.
10-24	1024.TSN
10-32	1032.TSN
1/4-20	1420.TSN
5/16-18	518.TSN
3/8-16	316.TSN
1/2-13	113.TSN

METRIC	
SIZE	PART No.
M5 x .8	M5.TSN
M6 x 1.0	M6.TSN
M8 x 1.25	M8.TSN
M10 x 1.5	M10.TSN
M12 x 1.75	M12.TSN

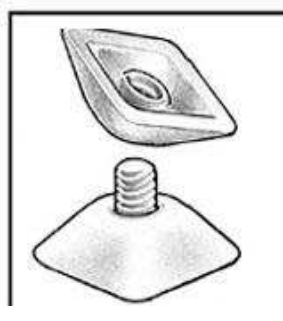
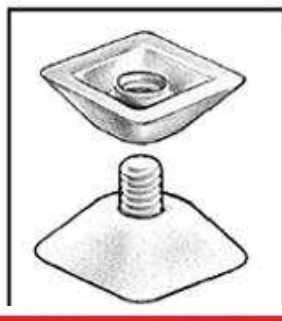
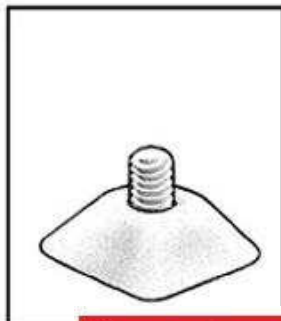

Use two Slope Nuts to install with a wrench

Carriage Bolt Adapters

Convert a square neck carriage bolt into an unslotted truss head bolt.

- Black Nylon - UV Resistant
- Protects the sign face
- 1.2" Outside Diameter



PART 3125.NWCB
 Fits 5/16 Carriage Bolts

PART 375.NWCB
 Fits 3/8 Carriage Bolts



Everything you need: Technical support, custom solutions and timely delivery

QUESTIONS, QUOTES & SOLUTIONS: TOLL-FREE 1.888.584.6283 OR SALES@LPFAST.COM

Automotive Security



LOSS PREVENTION

FASTENERS & TOOLS™

div. of Ultra Fasteners Inc

www.LPfast.com

PH 1.888.584.6283

License Plate, Light Bars Roof Racks & Electronics

High Security License Plate Screws Fits Domestic & Import Cars



Tools not available in hardware stores

Bulk & Pre-Packaged Options



Anti-Theft License Plate Screws

RETAIL COUNTERTOP MERCHANDISER

Pre-Packaged High Security License Plate Screws: 4 Universal Screws & 1 Tool

Price includes your company name & details
or order with your customers information

AUTOMOTIVE SECURITY SCREWS & SECURITY NUTS



LICENCE
PLATE
Security
Screws

INCH
&
METRIC

AUTOMOTIVE ACCESSORIES



ROOF
RACK
Security
Nuts

LIGHT BAR
Security
Screws
& Nuts



QUESTIONS, QUOTES, AND SOLUTIONS: Toll-free 1.888.584.6283 or sales@LPfast.com

SECURITY FOR LIGHT POLES



LOSS PREVENTION

FASTENERS & TOOLS™

div. of Ultra Fasteners Inc

www.LPfast.com

PH 1.888.584.6283

Wire Theft Solutions



STOP WIRE THEFT SOLVE COSTLY LIGHT POLE WIRE THEFT HEAVY DUTY HAND HOLE COVERS

★ LABOR - MATERIAL - COMMUNITY FRUSTRATIONS ★
★ SAFETY ISSUES - BUDGETS ★

HHC INSPECTION COVERS

Prybar Resistant

Best Security use with Ultra-Lok High Security Bolts



Removable with everyday tools

Single Hole Shown
Various Options Available



7/16" MATERIAL THICKNESS



1/4" THICK U-CHANNEL



Penta Head

Machine Bolts, Lag Bolts & Tools



LOSS PREVENTION FASTENERS™
div. of Ultra Fasteners Inc

Penta Head Sockets
Sold individually

Penta Head Size are often referred to as....



Part # .565" Tool
562PB.375S



Part # .840" Tool
875PB.500S



Part # .865" Tool
875PBL.500S



Part # .966" Tool
100PB.500S

or buy as a kit



Part # PTOOL.KIT
4 Penta Sockets
1 of each size

QUESTIONS, QUOTES, AND SOLUTIONS: Toll-free 1.888.584.6283 or sales@LPfast.com

T-Groove Tools for all sizes of T-Groove Nuts & Screws

Tri-Groove, Trident, Tampruf etc

The most versatile T-Groove socket in the world!

Standard Socket



4 Flats allows use of open end wrench and/or 12 point socket over the end

Deep Socket 2-1/2"



YES!
We have all sizes of the nuts

—All Sockets made of Steel. Black Oxide finish—

DEEP/LONG REACH T-Groove Socket

overall length 2-1/2"

Hard to reach & long studs

PART No.	Description	Fits Sizes
LPF420 3/8 drive	Standard Socket 1-1/4" socket length,	10-24,10-32, 1/4-20, 1/4-28, 5mm, 6mm 3/4" socket O.D.
LPF420.2 3/8 drive	Deep Socket/Long Reach 2-1/2" Socket Length approx 2" of throw	10-24,10-32, 1/4-20, 1/4-28, 5mm, 6mm 3/4" socket O.D.
LPF430 3/8 drive	Standard Socket 1-1/4" socket length	5/16, 3/8, 7/16 m8, m10 .980" socket O.D.
LPF430.2 3/8 drive	Deep Socket/Long Reach 2-1/2" Socket Length approx 2" of throw	5/16, 3/8, 7/16 m8, m10 .980" socket O.D.
LPF440 1/2 drive	Standard Socket 1-1/4" socket length	1/2-13, 1/2-20, M12, M14 1.25" socket O.D.
LPF440.2 1/2 drive	Deep Socket/Long Reach 2-1/2" Socket Length approx 2" of throw	1/2-13, 1/2-20, M12, M14 1.25" socket O.D.
LPF475	Universal Socket 2" socket length	5/8, 3/4, m16, m18, m20 1.55" socket O.D.

TGBIT.AST

Holt Head Friendly



Set of 4 Bits, Fits all Sizes of T-Groove Screws

(not compatible with T-Groove Nuts)

YES! We have T-Groove Screws



LOSS PREVENTION
FASTENERS & TOOLS®

div of Ultra Fasteners Inc

www.LPfast.com

PH 1.888.584.6283



When the fastener needs to be
high security | tamper resistant | anti-theft



PART # TPSOC.AST

Inch & Metric



Includes Robust Storage Box

6-Lobe Pin in Sockets for use with hand tools

Bits: S2 steel, Sockets: heat treated chrome vanadium

13 Piece Set Includes:

T8, T10, T15, T20, T25, T27, T30 each 1/4" Drive

T40, T45, T47, T50, T55, T60 each 3/8" Drive



PART # HPSOC.AST

SAE (inch)



Features Robust Storage Box

SAE Hex Pin in Sockets for use with hand tools

Bits: S2 steel Sockets: heat treated chrome vanadium

13 Piece Set Includes:

5/64, 3/32, 1/8, 5/32, 3/16, 7/32, 1/4, each 1/4" Drive

9/32, 5/16, 3/8, 7/16, 1/2, 9/16, each 3/8" Drive



PART # MHPSOC.AST

Metric



Features Robust Storage Box

METRIC Hex Pin in Sockets for use with hand tools

Bits: S2 steel Sockets: heat treated chrome vanadium

13 Piece Set Includes:

2mm, 2.5mm, 3mm, 4mm, 5mm, 6mm, each 1/4" Drive

7mm, 8mm, 9mm, 10mm, 12mm, 14mm each 3/8" Drive



LOSS PREVENTION FASTENERS™ & Tools

SECURITY TOOLS



LOSS PREVENTION

FASTENERS & TOOLS™

div. of Ultra Fasteners Inc. www.LPfast.com PH 1.888.584.6283

STOPPING THEFT EVERY DAY™

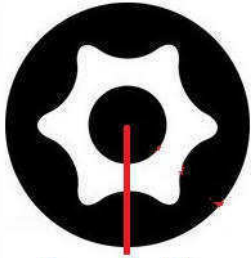

Security Pin



Ask us about 5 Lobe Pin tools

LOSS PREVENTION
FASTENERS & TOOLS®
div. of Ultra Fasteners Inc. www.LPfast.com PH 1.888.584.6283

PH 888.584.6283 sales@LPfast.com

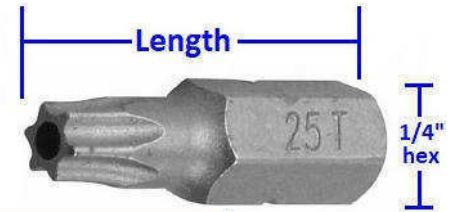

6 Lobe with Pin Security Driver Bits

SIZE	LENGTH 1"	LENGTH 2"	LENGTH 3"	LENGTH 3-1/2"	LENGTH 6"	LENGTH 12"	LENGTH 16"
1/4 Hex	1/4 Hex	1/4 Hex	1/4 Hex	1/4 Hex	1/4 Hex	1/4 Hex	1/4 Hex
T6	6T.250B	6T.250B2	X	6T.250B35	6T.250B6	X	X
T7	7T.250B	7T.250B2	7T.250B3	7T.250B35	7T.250B6	7T.250B12	X
T8	8T.250B	8T.250B2	8T.250B3	8T.250B35	8T.250B6	8T.250B12	X
T9	9T.250B	9T.250B2	9T.250B3	9T.250B35	9T.250B6	9T.250B12	X
T10	10T.250B	10T.250B2	10T.250B3	10T.250B35	10T.250B6	10T.250B12	X
T15	15T.250B	15T.250B2	15T.250B3	15T.250B35	15T.250B6	15T.250B12	15T.250B16
T20	20T.250B	20T.250B2	20T.250B3	20T.250B35	20T.250B6	20T.250B12	20T.250B16
T25	25T.250B	25T.250B2	25T.250B3	25T.250B35	25T.250B6	25T.250B12	X
T27	27T.250B	27T.250B2	27T.250B3	27T.250B35	27T.250B6	27T.250B12	X
T30	30T.250B	30T.250B2	30T.250B3	30T.250B35	30T.250B6	30T.250B12	X
T35	35T.250B	35T.250B2	35T.250B3	35T.250B35	35T.250B6	35T.250B12	X
T40	40T.250B	40T.250B2	40T.250B3	40T.250B35	40T.250B6	40T.250B12	X
T45	45T.250B	45T.250B2	X	X	45T.250B6	45T.250B12	X
T47	X	47T.250B2	X	X	47T.250B6	X	X
T50	50T.250B	50T.250B2	X	X	50T.250B6	X	X
T55	55T.3125B	55T.3125B.2			55T.3125B.6		X
T60		60T.3125B.2					X

minimums may apply.

ONE WAY SCREW Remover Tools

& Installation Tool: The socket shroud prevents the screw from slipping during use.

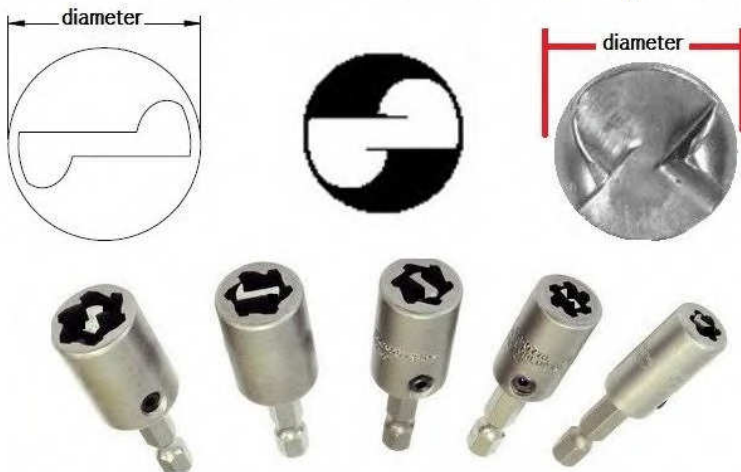

SCREW DIA	Fits Head Dia	Tool Part #
#6	.224"	OWRB.6
#8	.260"	OWRB.8
#10	.339"	OWRB.10
#12	.392"	OWRB.12
#14	.443"	OWRB.14
#15	.570"	OWRB.15
#16	.665"	OWRB.16
#18-20	.684"	OWRB.18

Measure the head O.D. to confirm correct fit

QUESTIONS, QUOTES, AND SOLUTIONS: Toll-free 1.888.584.6283 or sales@LPfast.com



Package & Bulk Quantities



Hex-Pin Security



Inch & Metric



1/4" Hex, 1" Long



1/4" Hex, 2" Long



3/8" Drive Socket



1/2" Drive Socket



Hole at each end
Short Arm L-Key

Size	Driver Bit Part No.	Power Bit Part No.	Part No.	Part No.	Part No.
5/64"	5/64.250B	5/64.250B.2	5/64.375S	5/64.500S	5/64.HLK
3/32"	3/32.25B	3/32.250B.2	3/32.375S	3/32.500S	3/32.HLK
7/64"	7/64.250B	7/64.250B.2	7/64.375S	7/64.500S	7/64.HLK
1/8"	1/8.250B	1/8.250B.2	1/8.375S	1/8.500S	1/8.HLK
9/64"	9/64.250B	9/64.250B.2	9/64.375S	9/64.500S	9/64.HLK
5/32"	5/32.250B	5/32.250B.2	5/32.375S	5/32.500S	5/32.HLK
3/16"	3/16.250B	3/16.250B.2	3/16.375S	3/16.500S	3/16.HLK
7/32"	7/32.250B	7/32.250B.2	7/32.375S	7/32.500S	7/32.HLK
1/4"	1/4.250B	1/4.250B.2	1/4.375S	1/4.500S	1/4.HLK
5/16"	5/16.250B	5/16.250B.2	5/16.375S	5/16.500S	5/16.HLK
3/8"	3/8.250B	3/8.250B.2	3/8.375S	3/8.500S	3/8.HLK
M2	M2.250B	M2.250B.2	M2.375B	M2.375B	M2.HLK
M2.5	M2.5.250B	M2.5.250B.2	M2.5.375B	M2.5.375B	M2.5.HLK
M3	M3.250B	M3.250B.2	M3.375B	M3.375B	M3.HLK
M4	M4.250B	M4.250B.2	M4.375B	M4.375B	M4.HLK
M5	M5.250B	M5.250B.2	M5.375B	M5.375B	M5.HLK
M6	M6.250B	M6.250B.2	M6.375B	M6.375B	M6.HLK

Spanner / Snake Eyes / Pig Nose Installation / Removal



1/4 Hex Bits Part #	Screw Size	Centre to Centre (A)	Screw Head Diameter
4S.250B	4	0.094"	0.183" - 0.235"
6S.250B	6	0.125"	0.226" - 0.290"
8S.250B	8	0.156"	0.270" - 0.344"
10S.250B	10	0.187"	0.313" - 0.399"
12S.250B	12	0.218"	0.357" - 0.454"
14S.250B	14, 5/16	0.250"	0.414" 0.525"
16S.250B		0.340"	
18S.250B		0.430"	
20S.250B		0.475"	



PART Number for use with
1SN.250B **SPANNER NUT** **SPANNER** **NUT**

Carbide Drill Bits

Carbide Drill Bits Page 46 for Concrete & Masonry

Drill Bit Tool Selection



SDS-PLUS

Fits all current and older SDS-PLUS rotohammers from AEG, Black & Decker, Bosch, DeWalt, Hitachi, Hilti, Kango, Makita, Metabo, Milwaukee, Porter Cable, Ramset, Red Head, Ryobi, Skil

SDS-MAX

Fits all current and older SDS-MAX rotohammers from Black & Decker, Bosch, DeWalt, Hitachi, Hilti, Kango, Makita, Metabo, Milwaukee

Spline

Fits all current and older Spline rotohammers from AEG, Black & Decker, Bosch, DeWalt, Hitachi, Kango, Makita, Metabo, Milwaukee, Ramset, Red Head, Ryobi



SDS-PLUS

Diameter	Drilling Dept (inch)	Overall Length (inch)	Part No.
1/4"	6"	8-1/4"	70730
3/8"	4"	6-1/4"	70736
	8"	10-1/4"	70742
1/2"	4"	6-1/4"	70748
	8"	10-1/4"	70752

STRAIGHT Shank

Diameter	Drilling Dept (inch)	Overall Length (inch)	Part No.
1/4"	4"	6"	70700
3/8"	4"	6"	70706
	10"	12"	70712
1/2"	4"	6"	70718
	10"	12"	70724

SPLINE

Diameter	Drilling Dept (inch)	Overall Length (inch)	Part No.
3/8"	5"	10"	70758
	8"	13"	70764
1/2"	5"	10"	70770
	8"	13"	70776

SDS-MAX

Diameter	Drilling Dept (inch)	Overall Length (inch)	Part No.
3/8"	7-1/2"	13"	70782
1/2"	7-1/2"	13"	70786
	15-1/2"	21"	70792
5/8"	15-1/2"	21"	70798



LOSS PREVENTION

FASTENERS

div of Ultra Fasteners Inc

PH 888.584.6283

www.LPfast.com

LICENSE PLATE SECURITY SCREWS

- Fits all makes & models of cars, trucks, and motorcycles
- Domestic and import
- Tamper resistant
- Reduces theft
- Peace of mind



Ultra 5 Lobe Security Stainless Steel Tough Security Screw

Convert any regular license plate screw to a security screw!



Universal size for license plates



STOP THIS

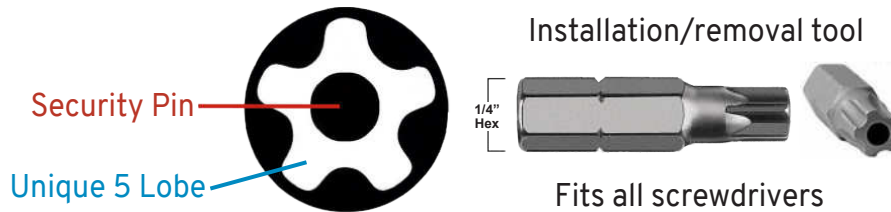

Tools not available in hardware stores!

Pre-packaged 4 Screws & 1 Tool

With *your* company name, logo, contact info, and part number

- Auto accessory stores
- Retailers
- Dealerships
- Fleets
- Community outreach
- Fundraisers
- Insurance companies



Countertop Merchandiser

- Resale in parts department
- Gift-A-Way for your customers
- Protect dealer plates from theft

- Packaged with your name
- Bar coded
- English and Spanish



STOPPING THEFT EVERY DAY™

QUESTIONS, QUOTES, AND SOLUTIONS: Toll-free 1.888.584.6283 or sales@LPfast.com



ULTRA FASTENERS USA™
Everything Fasteners

LINE CARD

EVERYTHING FASTENERS

Call us first!
1.888.508.9810

- ✓ Made in USA / Domestic Fasteners
- ✓ Huge Selection of Stainless Steel Fasteners
- ✓ Custom / Hard to Find Fasteners
- ✓ Packaged / Bulk & Custom Packaging
- ✓ Ask About Made in USA anchors



Flex-Lok Nuts



Concrete Fasteners

Sleeve / Wedge Anchors
Drop-in Anchors
Chemical Anchors
Screw Shields
Precast Screw Anchors
Concrete Screws
Threaded Rod
and more...

Socket Products

Button / Flat / Socket Head
Low Head Capscrews
Set Screws / Shoulder Bolts
Square Head Set Screws
Pipe Plugs / Dowel Pins
and more...



Inch / Standard Fasteners

GR5 / Gr8 Capscrews (Bolts)
High Grade L9 Fasteners
Nuts / Flat Washers / Lock Washers
Wood / Sheet Metal Screws
Steel / Stainless Steel
Standard / Custom Studs
Solar Fasteners
Flex Lok

Metric Fasteners

8.8 / 10.9 / 12.9 Capscrews
Nuts / Flat Washers / Lock Washers
Lock Nuts / Studs
Solar Fasteners

Call us first!
1.888.508.9810

NON-STANDARD / CUSTOM

Made from Print / Consultation
Prototyping / Multiple Materials
Bronze, Copper, Monel & more
British Threads / JIS / Acme
Milspec / Aerospace

Visit us online
UltraFastenersUSA.com



ULTRA FASTENERS USA
Hard to find Fasteners is our Specialty

Contact us / Inquiries

PH: 1.888.508.9810
Emails are replied fast!
office@UltraFastenersUSA.com

Address
2794 Peace Portal Dr
Unit # 135
Blaine WA 98230

